

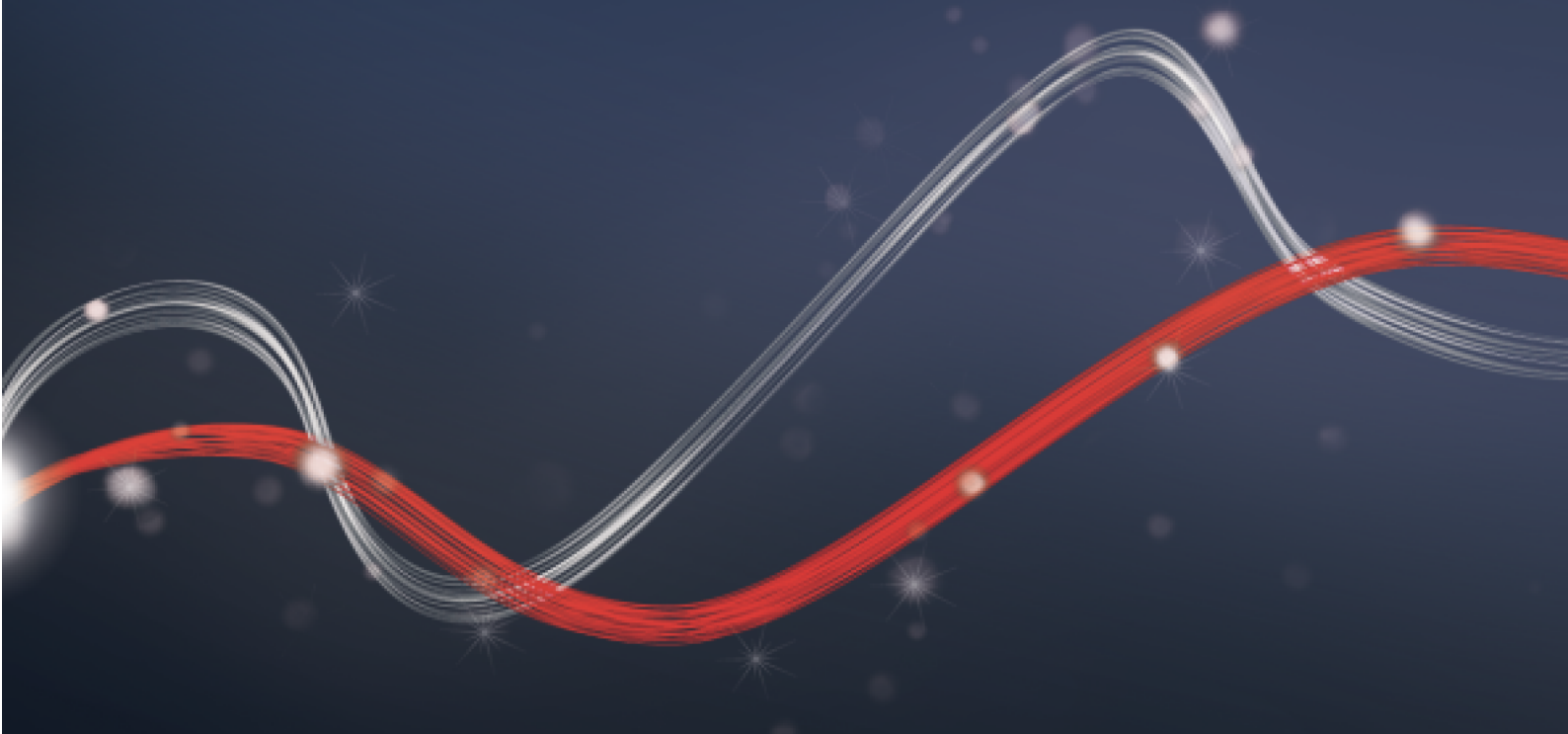

Be ahead



DEIMOS ULTRA BT A





Sliding gate automation systems

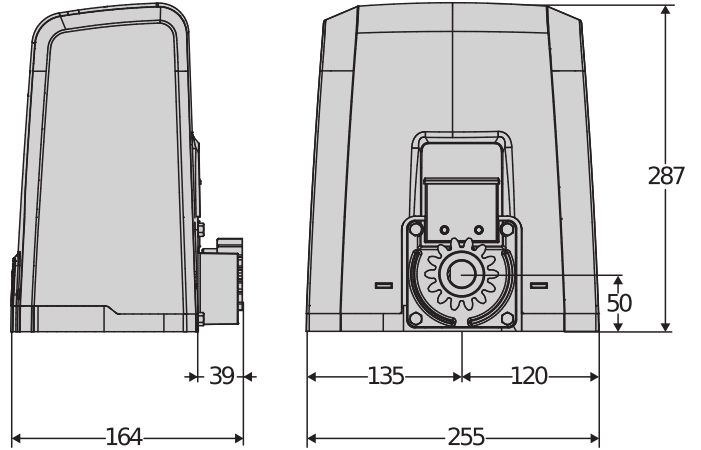

Range of operators for sliding gates weighing up to 600 Kg.
Maximum leaf speed up to 16 m/min.
Newly designed magnetic limit switch for quicker installation; precise and perfectly integrated with architecture of site.
Residential use.
Control unit designed for use with the Blue Entry system.

Relevant features



Magnetic limit switches: this type of limit switch ensures safe and precise installations in any ambient condition



Control unit with programming display: the Merak control unit with programming display with pre-programmed scenarios helps the installer in the programming phase; the control unit is arranged in an oblique way, to facilitate reading and making the settings.

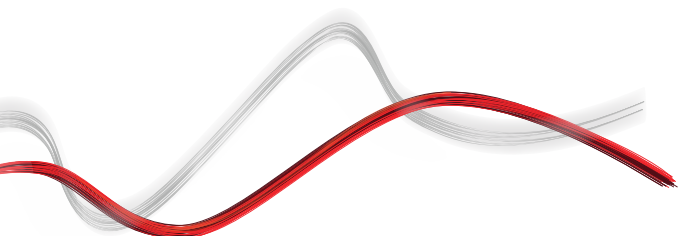



Sliding gate automation systems



Relevant features



Front screws: this arrangement of the casing screws offers ease and convenience during installation and maintenance, even when there is limited space.



Release lever with personalised key: the release lever simplifies motor release and the personalized key ensures its uniqueness, for better safety

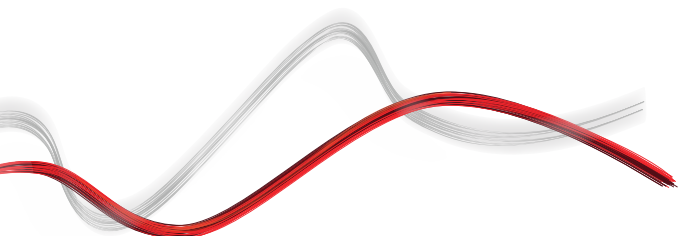



Sliding gate automation systems



DEIMOS ULTRA BT A

Code	Name	Description	
P925221 00002	DEIMOS ULTRA BT A400	Operator 24 V for sliding gates up to 400 kg in weight. Leaf speed 12 m/min. U-Link and Magnetic limit switch	U-Link
P925221 00003	DEIMOS ULTRA BT A400 V	Operator 24 V for sliding gates up to 300 kg in weight. Leaf speed 16 m/min. U-Link and Magnetic limit switch	U-Link
P925223 00002	DEIMOS ULTRA BT A600	Operator 24 V for sliding gates up to 600 kg in weight. Leaf speed 12 m/min. U-Link and Magnetic limit switch	U-Link
P925223 00003	DEIMOS ULTRA BT A600 V	Operator 24 V for sliding gates up to 360 kg in weight. Leaf speed 16 m/min. U-Link and Magnetic limit switch	U-Link
R925265 00002	DEIMOS ULTRA BT KIT A400 FRA	Complete kit 24 V for sliding gates weighing up to 400 kg. Leaf speed 12 m/min. U-Link and Magnetic limit switch	U-Link
R925269 00002	DEIMOS ULTRA BT KIT A600 FRA	Complete kit 24 V for sliding gates weighing up to 600 kg. Leaf speed 12 m/min. U-Link and Magnetic limit switch	U-Link

MERAK: Incorporated control unit for one 24V operator for sliding gates

MERAK - Built-in



- Incorporated control unit for one 24V operator for sliding gates
- Card power supply: 230 V single-phase
- Operator power supply: 24V 80W
- Main functions: automatic closing, quick closing, pedestrian passage, people-present operation, maintenance warnings.
- Compatibility: HQSC-D, QSC-D MA
- Principal features: removable terminal boards with new colour standard, simplified scenario programming with display, integrated dual channel receiver, protection against crushing based on D-Track system, slowdown during opening and closing







	DEIMOS ULTRA BT A400	DEIMOS ULTRA BT A400 V	DEIMOS ULTRA BT A600	DEIMOS ULTRA BT A600 V
Control unit	MERAK SL1	MERAK SL1	MERAK SL2	MERAK SL2
Board power supply	230 V	230 V	230 V	230 V
Supply voltage	24 V	24 V	24 V	24 V
Power consumption	50 W	50 W	70 W	70 W
Max. door/gate weight	400 kg	300 kg	600 kg	360 kg
Gate panel speed	12 m/min	16 m/min	12 m/min	16 m/min
Type of limit switch	Magnetic	Magnetic	Magnetic	Magnetic
Pinion module	4	4	4	4
Slowdown	Yes	Yes	Yes	Yes
Locking	Mechanical	Mechanical	Mechanical	Mechanical
Release	Lever-operated with personal key	Lever-operated with personal key	Lever-operated with personal key	Lever-operated with personal key
Impact reaction	D-Track	D-Track	D-Track	D-Track
Frequency of use	intensive	intensive	intensive	intensive
Protection rating	IP44	IP44	IP44	IP44
Environmental conditions	-20 ÷ 55 °C	-20 ÷ 55 °C	-20 ÷ 55 °C	-20 ÷ 55 °C



Sliding gate automation systems



RECOMMENDED ACCESSORIES

	<p>new D114093 00003 - RADIUS LED BT A R1</p> <p>Flashing light with incorporated antenna for motors with 24 V power supply.</p>		<p>new D114168 00003 - RADIUS LED BT A R1 W</p> <p>Flashing light with incorporated antenna for motors with 24 V power supply. White flashing light.</p>
	<p>new D114094 00003 - RADIUS LED BT A R0</p> <p>Flashing light without incorporated antenna for motors with 24 V power supply.</p>		<p>D221073 - CP</p> <p>plastic rack, 4-module, cross-section 22 x 22 mm, length 1 m, screw-fitted into slots attachment Max. load capacity 600 kg.</p>
	<p>D571053 - CVZ</p> <p>steel rack, 4-module, cross-section 30 x 12 mm, length 1 m, screw-fitted on supports attachment Max. load capacity 1000 kg.</p>		<p>new P111782 - COMPACTA A20-180</p> <p>Pair of photocells adjustable 180° horizontally. 20 metre range. 12-33 VAC/15-35 VDC power supply.</p>
	<p>N999320 - CVZ-S</p> <p>steel rack, 4-module, cross-section 30 x 8 mm, length 1 m, screw-fitted on supports attachment Max. load capacity 800 kg.</p>		<p>N999151 - SFD</p> <p>Base plate for DEIMOS series (supplied with operator)</p>
	<p>P111468 - B EBA R5 485 LINK</p> <p>Expansion board for connection of central units with serial controls management</p>		<p>P125035 - SL BAT2</p> <p>Emergency battery kit for Deimos BT A, Ares BT A, Deimos Ultra BT A, Ares Ultra BT A.</p>

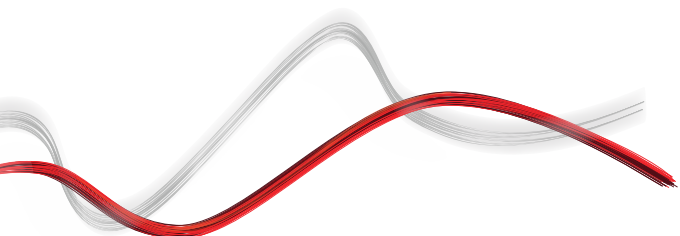



Sliding gate automation systems



What is U-Link?

The technology that gives you more power

U-Link, Universal Link, is an exclusive BFT platform that can be used to create high-tech ecosystems. In Home Access Automation, it can be used to communicate with all home access automation devices of any brand. This saves you time and allows you to control everything easily and without any worries.

It is intuitive

Easy to install and to use

It is scalable

You can add as many devices as you want

It is flexible

It allows you to create groups of interconnected products

It is practical

Works with or without an internet connection

It is functional

Its settings can be controlled remotely using dedicated applications



Sliding gate automation systems



Everything on one screen: find out more about this amazing technology

A world-exclusive platform that **can be used to create high-tech ecosystems** offering a vast range of solutions for many different sectors.

This proprietary platform which is a key feature of BFT products, thanks to the B-EBA cards and the Clonix U-Link receiver, is suitable for any protocol or product for access automation (including BFT products non-BFT ones and older versions) and it can be used in a variety of different sectors. This means any device becomes a smart device which can be interconnected with other systems, using a language that is becoming universal.



U-Control HOME

U-Control HOME is the application that allows you to open the gate to your home and to remotely control BFT automations using your own smartphone. The iOS version can be used to automatically open the automation when you are close to it.



U-Base 2

A software package for installation, performing maintenance and identifying any faults in the U-Link compatible operators, easily and conveniently.



U-SDK

U-SDK is the application which allows BFT automations to be made compatible and easily integrated with a BMS network.



Clonix U-Link

Connect non-native U-Link and non-BFT products to U-Link systems.

Is it possible to connect non-native U-Link BFT operators or other brands of products to U-Link? Yes, thanks to the Clonix receivers. Accessories which accept no limits.



B-EBA

A direct link to your operators.

The B-EBA expansion cards make it possible to connect external devices such as PCs, smartphones and tablets to a BFT operator and a Clonix receiver or to connect multiple BFT products in a U-Link network. These accessories integrate with U-Link technology and with Bluetooth, Wifi, Z-Wave and TCP/IP protocols as well as with the RS485 serial interface. A device that demonstrates exactly what BFT means by interconnectivity.

