

TX7004

Intelligent Addressable Fire Alarm Control Panel
Installation and Operation Manual



Product Safety

To prevent severe injury and loss of life or property, read the instruction carefully before installing the Control Panel to ensure proper and safe operation of the system.



European Union directive

2012/19/EU (WEEE directive): Products marked with this symbol cannot be disposed of as unsorted municipal waste in the European Union. For proper recycling, return this product to your local supplier upon the purchase of equivalent new equipment, or dispose of it at designated collection points.

For more information please visit the website at www.recyclethis.info

Disclaimer

The information in this manual is furnished for informational use only and subject to the change without notice. While every effort has been made to ensure that the information contained in this user manual is accurate, reliable and up to date. The TANDA Technology cannot be held responsible for inaccuracies or error that may appear in this manual.

Document Improvement

There is always room for improvement, your comment will help us the quality of this manual. Do not hesitate to send report any error, inaccuracy or improvement request on this user document by email to info@tandauk.com

EN54 Part 2&4 Compliance

TX7004 Intelligent Fire Alarm Control Panel complies with the requirements of EN54-2:1997 + A1:2002 & EN54-4:1997 + A1:2002 + A2:2006



EN54 Standard Conformity Information

 2831 19
TANDA(UK) LIMITED FOURTH FLOOR 30-31 FURNIVAL STREET LONDON EC4A 1JQ(Type 1, Option 2 Crosslisting)
TX7004 2831-CPR-F2013
EN54-2:1997 + A1:2002 & EN54-4:1997 + A1:2002 + A2:2006



EN54-2 & EN54-4
1330h/01

Table of Content

1 Introduction	6
1.1 Overview	6
1.2 Feature and Benefits.....	7
1.3 General Image	7
1.4 Technical Specification	8
2 Installation	9
2.1 Names and Location.....	9
2.2 Installation Preparation	10
2.3 Cabinet Installation	11
2.4 Terminals and Connection.....	12
2.4.1 Power Supply	12
2.4.2 Input/output.....	13
2.4.3 Loop and Network	14
3 Control Panel Descriptions	15
3.1 Control Pane Fascia.....	15
3.1.1 LED Indicator.....	15
3.1.2 Display and Control Keypads Function	17
3.1.3 Zone LED Indicator	19
3.2 Type for Sound Indication	19
4 System Commissioning	20
4.1 Preparation.....	20
4.2 Keypad/Keyboard Locking	20
4.3 Basic Commissioning Procedures	20
5 Operation and Commission Menu	21
5.1 Navigating Menu Hierarchy	21
5.1.1 View Panel Status	22
5.1.2 View Delay Information	24
5.1.3 View Disable Information	24
5.1.4 View Test Information	25
5.1.5 View Dirty Information.....	25
5.1.6 View Output Connection.....	25
5.1.7 View History Log.....	26

5.2 Operation Menu Hierarchy.....	27
5.2.1 Time and Date Setup	28
5.2.2 Printer Setup.....	28
5.2.3 Delay Mode Setup.....	28
5.2.4 Disable/Enable Setup.....	29
5.2.5 Test Setup.....	32
5.2.6 Calibrate Touch Screen.....	33
5.3 Commission Menu Hierarchy.....	34
5.3.1 Panel Setup	36
5.3.2 Programming.....	39
5.3.3 Pass code Setup	43
5.3.4 Communication Setup	44
5.3.5 Project Name	46
5.3.6 Panel Commission.....	47
5.3.7 System Initialisation.....	48
6 Maintenance	49
6.1 Maintenance Schedule	49
6.2 Trouble Shooting	50
7 Battery Capacity.....	51
8 Returns and Warranty Policy.....	51
9 Appendix 1	52
9.1 EN54 Part 2 /4 Compliance	52
9.2 Index of Information Required	53

1 Introduction

1.1 Overview

The TX7004 comprise of a range of analogue addressable, microprocessor based fire alarm control equipment to offer flexibility in both design and operation. The System is modular concept for easy tailoring of system design, to meet the full requirements of the project. The TX7004 Intelligent Fire Alarm Control Panel is designed and manufactured to meet the requirement of BS EN54 Part 2&4.

The TX7004 is designed to provide early warning fire detection, to quickly identify the location of fire and provide user definable text informing the occupants of the building of potential smoke spread. Simultaneously, the TX7004 will alert and evacuate the occupants, and control all necessary auxiliary command functions such as elevator control, air handling shut down, gas shut off & damper control, as per the cause and effects requirements configured though Command Builder Set-up.

The TX7004 modular construction panel, capable of supervising four [4] monitored detection loops expandable up to six [6] loops on standalone basis. Each loop is capable to accommodate of 254 addressable devices of any combination with T&A protocols, namely intelligent sounder strobe TX7300 & intelligent sounder TX7320 complying with EN 54-3, rate of rise and fixed temperature heat detector TX7110 complying with EN 54-5, photoelectric smoke detector TX7100 complying with EN 54-7, intelligent manual call point TX7140 complying with EN 54-11, intelligent reflective beam detector (TX7130) complying with EN 54-12, input and output module TX7200, TX7210, TX7220 complying with EN54-18, and loop isolator TX7230 complying with EN 54-17. The T&A devices are fully loop powered to support saving cost of the cable.

These systems incorporate a number of features to allow easy operation through a user-friendly menu. The TX7004 has a LCD touch screen and Keypad menus for alternative operation with large button access to operate the keypad control by fire brigade personnel providing total user-friendly interface for browsing and programming. Added the commission features such as colour coded loop mapping, dual address and device mismatch monitoring, one-man test, simplified command builder's configuration that has proved to be highly rated by both commissioning and service engineers.

The Control Panel has multiple built-in features. The loop card has built-in surge protection and the communication card interface support multiple interface protocol such as USB, Ethernet, CAN Bus, Serial, RS485, Fiber Optic in one single card. The panel is Built-In Printer and 160 LED Zones Indicators. The panel provides variety of inputs and outputs interfaces and auxiliary such as Output to Sounder, F.P.E., Alarm and Fault output, Relays and Power Auxiliary.

1.2 Feature and Benefits

- Compliance EN54-2 & N54-4
- Using advance microprocessor technology with Large memory capacity
- Enhance user interface combining LCD Touch screen and keypad access
- Support real time visual algorithm
- Enhance false alarm prevention
- Keypad and PC programming
- Support Multiple interface protocol such as USB/Ethernet/Can Bus/Serial/RS485/Fiber Optic
- Support Loop Powered devices for extra saving on cable cost
- Built-In Printer and 160 LED Zones Indicators

Commissioning Advantage

- Auto Enrolling of Devices
- Loop Mapping with colour coding status
- Monitor device mismatch and dual address conflict
- Command Builder to create requirements for fire event scenario
- With Loop protection against power surge
- One-man test with On/Off sounder
- Programming Protection

System Capacity

- Up to 4 loop
- Support 254 Devices/One loop (1,016 ideal)
- Network up to 512 Node
- Programmable Capacity
- Zones up to 3000
- Sounders Groups 1-1000
- Other Groups 1001- 2000
- Built-in 160 LED Zones Indicator

1.3 General Image



Figure 1

1.4 Technical Specification

- Compliance EN54-2 & 4
- Input Voltage 230VAC +10%-15%, 50Hz
(120VAC, 60Hz, it is not applicable for EN54 & Not tested by LPCB)
- Input Current Consumption 1A
- PSU Output To CIE 21.5~28.5VDC
- Batteries Maximum Charge Capacity: 2 x 12V / 28AH
Maximum Charge Current: 1.2A
I maxA: 0.93A
I maxB: 2.53A
Minimum Quiescent Current: 0.45A(Imin)
Maximum Internal Resistance: 1.0Ω
Rechargeable-Lead acid type battery
- Recommended manufacturer and model of battery: PS-12280 12V28AH (Tested With CIE By LPCB)
- Networking and Interfaces Can Bus [loop]
Panel to panel communication 512
Number of Panels USB, RS485 Serial, RS232 Serial, Ethernet
Interface Port
- System Capacity 1000 Fire Events, 10,000 General Event
Memory [Non-Volatile] 3,000 programmable
Zones 3,000 programmable
Total Group 1,000 programmable
 Sounder Group 2,000 programmable
 Common Group
- Loop Specifications T&A, Value range from 1 to 254
Protocol/Addressing 4 Loop
No. of Loop Built-in 4kV Surge protection
Protection 16~24Vdc /120mA
Power rating 1.0Km Max Length/2 x 1.5mm² solid core Fire resistance
Cabling (subject to local installation codes)
- Recommended Wiring Intelligent Safety & Security Technology Limited
 ISST-SFR3/ 711c-(cl-5) Ventcroft Limited
 NoBurn XPS/ 682e/01 Draka UK Limited
 FT30 SAFFIRE/ 1134j Context Plus Ltd
 Context Plus/682a-(cl-3) Prysmian Cables & Systems Limited
 FP200 Gold LSOH/ 077k/01 And all LPCB approved Fire cables
Recommended Cable Length ≤1000m
- Panel Input/outputs 4 circuits: Normally Open/Close
Programmable Relays 1 Circuit: Current Limited 24Vdc (for future use)
Programmable Input 19~28Vdc (Current Limited)
Programmable Auxiliary Power 2 Circuits: 18~28Vdc (Current Limited)
Fixed Outputs (FPE/Sounder) 24 LED Status/ 160 Zone Indicators
- Indicator 7" TFT Touch Screen
- Display 5 Brigade buttons and Programming Keypad
- Keypad Flat sheet Metal / with outer glass door, Orange stripe
- Material / Color 530 mm x 490 mm x 135 mm
- Dimension Lx W x H 16.70 Kg
- Weight -5°C~+40°C
- Temperature 0 to 95% Relative Humidity, Non condensing
- Humidity

2 Installation

This Fire Alarm Control Panel must be installed, commissioned and maintained by a qualified or factory trained service personnel. The installation must be installed in compliance with all local codes having a jurisdiction in your area or BS 5839 Part 1 and EN54.

NOTE: Read this manual fully and review drawing before starting the installations.

Warning: The electronic components inside the panel are vulnerable to damage by electrostatic discharges. It is recommended to wear a wrist strap designed to prevent the build-up of static charges within the body, before handling any electronic circuit board.

The manufacturer takes no responsibility for damage or injury occasioned as a result of failing to install or operate or maintain the control panel in accordance with these manual and other good practices.

2.1 Names and Location

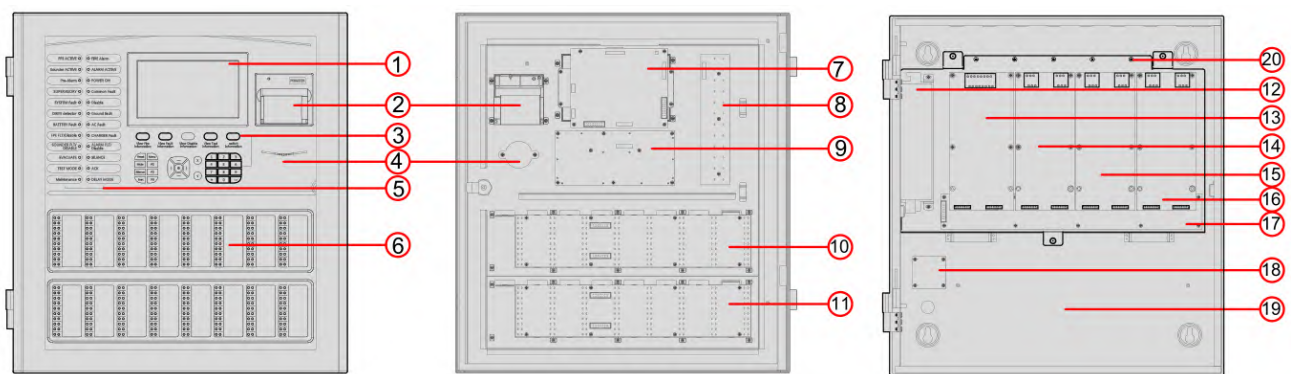

Figure 2

- | | | |
|------------------------|-------------------------|--------------------------|
| ① LCD Touch Screen | ⑦ Main Board | ⑫ Power Supply Unit |
| ② Printer | ⑧ LED Circuit Board | ⑬ Power Management Board |
| ③ Operational Keypad | ⑨ Keypad Circuit Board | ⑭ Loop 1 & 2 Board |
| ④ Buzzer | ⑩ First Zone LED Board | ⑮ Loop 3 & 4 Board |
| ⑤ Status LED Indicator | ⑪ Second Zone LED Board | ⑯ Communication Board |
| ⑥ Zone LED Indicator | | ⑰ Mother Board |
| | | ⑱ Power terminal Board |
| | | ⑲ Battery Space |
| | | ⑳ Earth stud |

A standard FACP consists of mother board, main board, loop board, Power management board, indication board, and zone indication panel.

Mother board

The mother board is installed on the back of the FACP, which connects with power management Board, Main board, loop board, network board and communication board.

Main board

Main board is the core of the FACP, which contains CPU and interfaces to other main and optional components of the system.

Loop board

As the signal interface of the FACP, the loop board contains ports for detection output that connects field devices and the FACP into a complete fire alarm system.

Power management board

It provides power to the main board, loop board and printer. Its backup feature ensures that devices registered during commission will not be lost in case of power fault.

Display and operation part

This part consists of switch board, keypad board, and LCD. It is used to indicate and display different status of the system, and enables operations through keypad (browsing, setting, printing and etc).

Zone indication panel

The zone indication panel can indicate zone wise status and point status of the particular device.

2.2 Installation Preparation

Plan the location of the panel, make sure the installation location is free from dust, debris and keep under the humidity and temperature range. The panel should be installed in an open wall and floor space and mounted at the eye level of the user so the panel can be installed and serviced without any obstruction.

From the box, the control panel is housed in a single metal enclosure incorporating with hinge door with outer glass door using magnetic door lock, display board, buttons and zone indicator circuits and panel printers. Inside the panel there are main board, loop board, communication board, and power supply board are also fitted in the panel enclosure.

The cabinet is designed for Semi-flush mounting which is also possible for surface mounting if requirements demand. [Refer to Fig. 3]. It is recommended to remove the Circuit Board chassis inside the cabinet before drilling or fixing the cabinet to the wall.

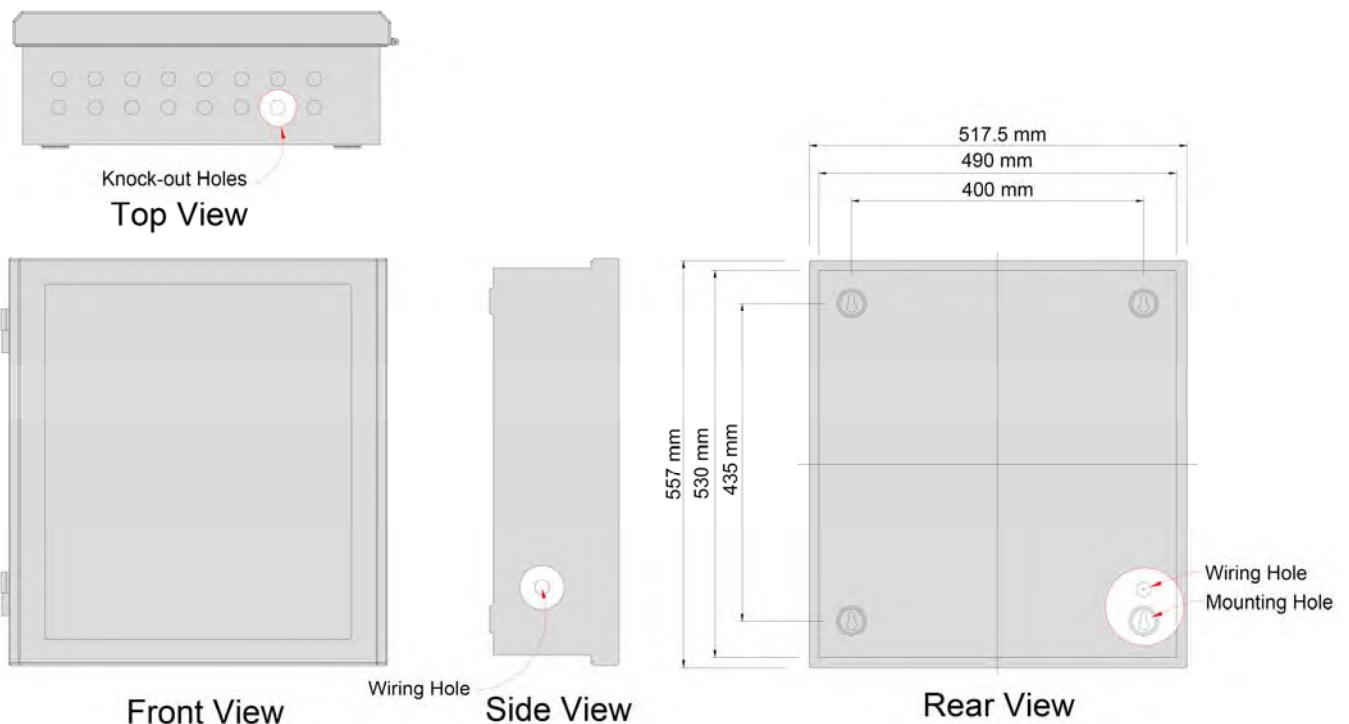

Figure 3: Panel Structure

2.3 Cabinet Installation

1. Removing of the Door and Chassis:

- Open the panel. Locate and unplug the 20 pin flat ribbon [printed P1 to main ports] cable between the Main Board and the Power Board end. Disconnect the enclosure grounding [Fig. 4].
- Carefully remove the door from the support open hinged door [Fig. 5].
- Take out the circuit board chassis by unscrew the 3x fix screw and power board by unscrew the 4x fix screw. Carefully remove the chassis assembly and place in a secure area.

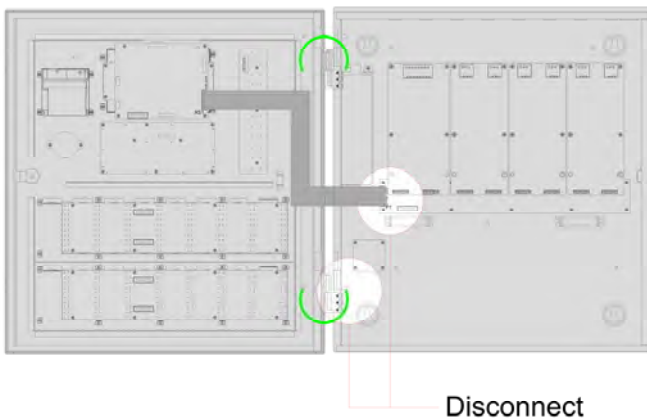

Figure 4: Cable disconnection

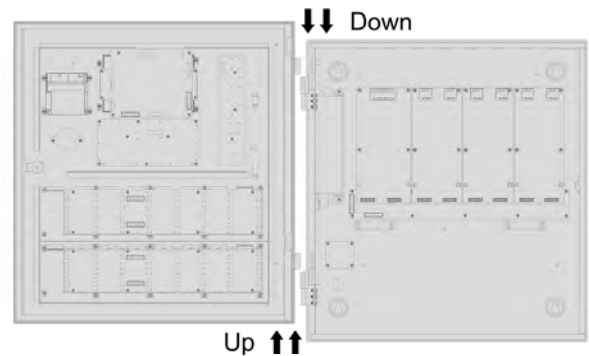

Figure 5: Door dismantle

2. Mounting the Cabinet

- Locate and place the cabinet and marked the four holes for mounting.
- Plan the cable installation. Remove the necessary knockout on the top of cabinet.
- Mount the cabinet and install the screws and washer tightly.

Note: Make sure the cabinet is fixed to a flat surface otherwise the enclosure will twist.

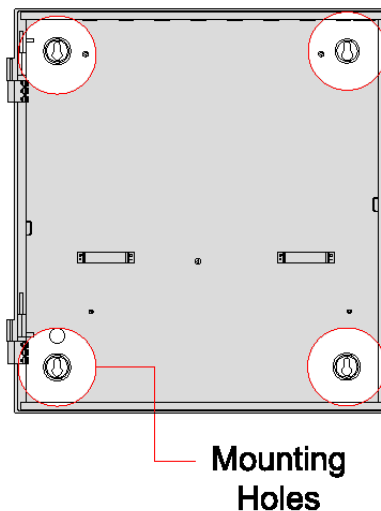

Figure 6: Panel Chassis

3. Re-mounting of the Door and Chassis.

- Carefully mount the door and mount the chassis assembly by handling the metal sheet onto the support bracket and mounting threaded bracket.
- Plug the flat ribbon cable to the correct socket and wire again the grounding cable to the mounting threaded studs.

2.4 Terminals and Connection

Notes:

1. Practice the General Guideline on laying cables and termination.
2. There are sixteen [16] knockout holes on the top of the enclosure. It is recommended to use a cable gland or cable sealing to avoid abrasion of the cable and foreigner matters entering inside the control panel.
3. Lay the cable properly, do not stretch the cable tight inside the cabinet allow some looseness. Loop cable shall not mix with power cables allow some gap. Jointing of cables should be avoided as far as possible.
4. Ensure all electrical connection is tested before connection and observe the polarity of the battery cables.
5. All the loop, input/output circuit cable, sounder cables must be provided with identification mark or identifiers indicating the loop number in accordance with the cable loop circuit.
6. Make sure all the cables are arranged and marked properly for troubleshooting and maintenance.
7. Through the earth stud bonding enclosure and earth.

2.4.1 Power Supply

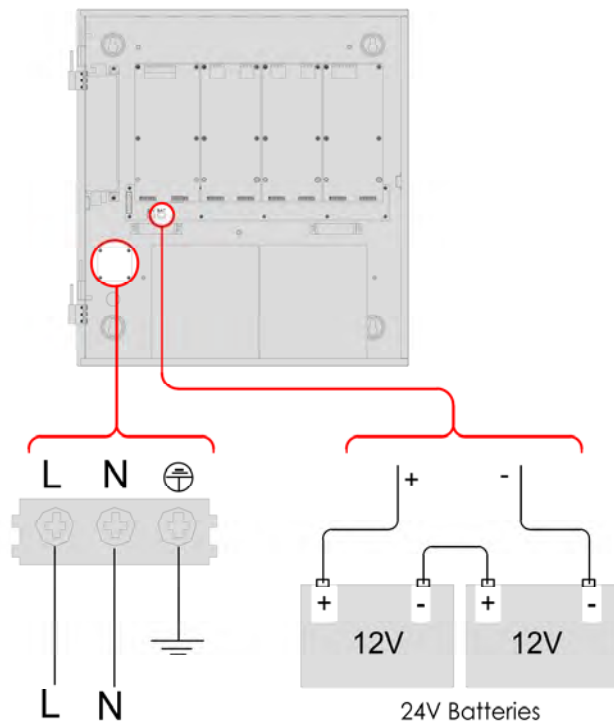

Input: 100VAC to 240 VAC
50/60Hz
Current: 1A
Fused: 2 A delayed
Cable Type: 1.5mm²

Main Power Supply

Input: 230VAC +10%-15%, 50Hz
Cable Type: 1.5mm² Standard fire resistance cable
Location: P1 power terminal board

Secondary Power Supply

Size: 2 x 12V / 28AH
Type: Rechargeable-Lead acid battery
Cable type: Supplied
Location: P12 mother board

Notes: Only Input Voltage range 230VAC +10%-15%, 50Hz applied LPCB certification, 120VAC, 60Hz, it is not applicable for EN54 & Not tested by LPCB

Figure 7: Power Wiring Details

2.4.2 Input/output

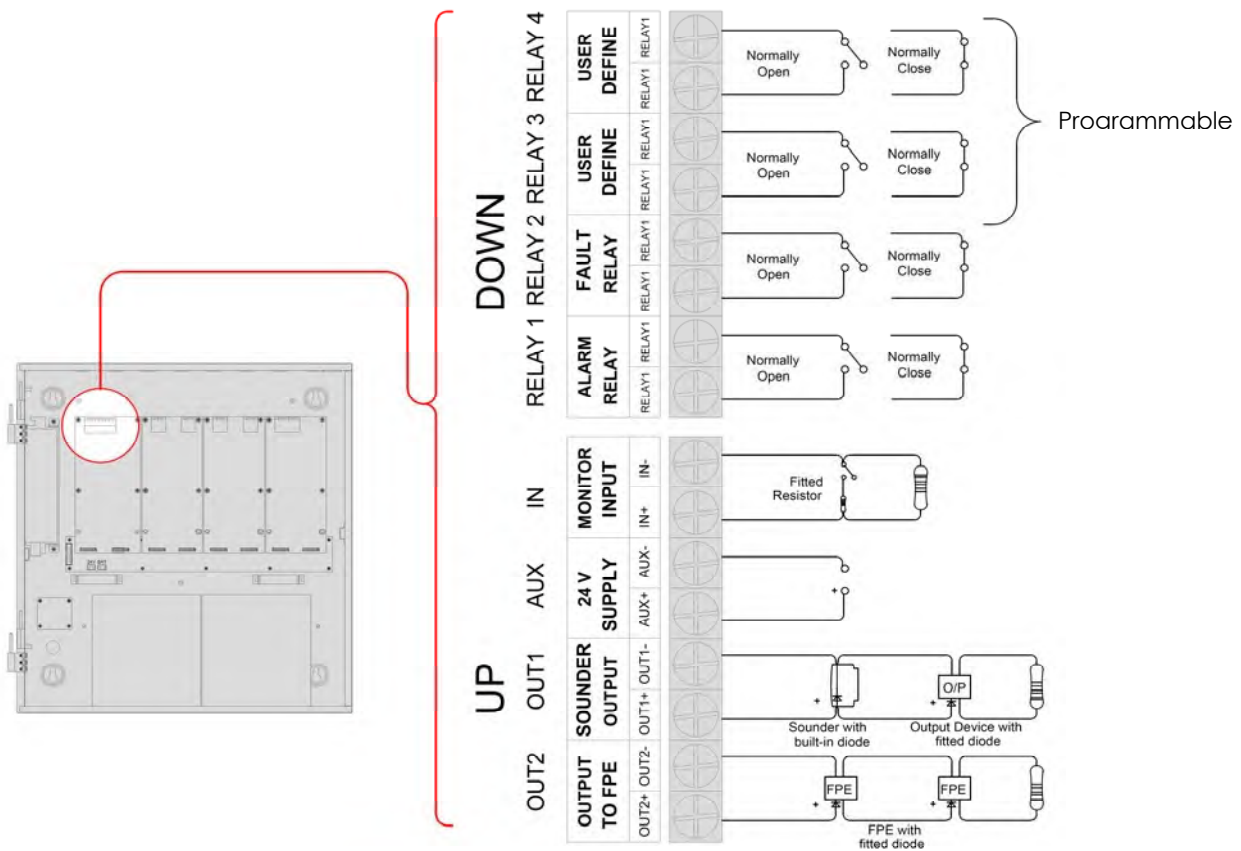

Figure 8: Input/output Wiring Details

Input/output Functionality

Terminal	Description	Monitoring	When off	When on
OUT1	Output to Sounder	Monitored [4.7KΩ EOLR]	-0.5 to +1.3VDC	+24VDC
OUT2	Output to F.P.E	Monitored [4.7KΩ EOLR]	-0.5 to +1.3VDC	+24VDC
AUX	Power Supply	Monitored	Set to 3: 24VDC Continuous Set to 4: 0V for 15 seconds- Resettable	-
IN	Remote access (for future use)	Unmonitored	-	-
RELAY1	Alarm Relay	Unmonitored	Normally Open/Close	Change-over
RELAY2	Fault Relay	Unmonitored	Panel On- Normally Open/Close Panel Off- Normally Open/Close [EN54-2]	Change-over -
RELAY3	User Define	Unmonitored	Normally Open/Close	Change-over
RELAY4	User Define	Unmonitored	Normally Open/Close	Change-over

NOTE: Change the RELAY normally Open/Close setting by the Jumpers on the Power Management Board.

2.4.3 Loop and Network

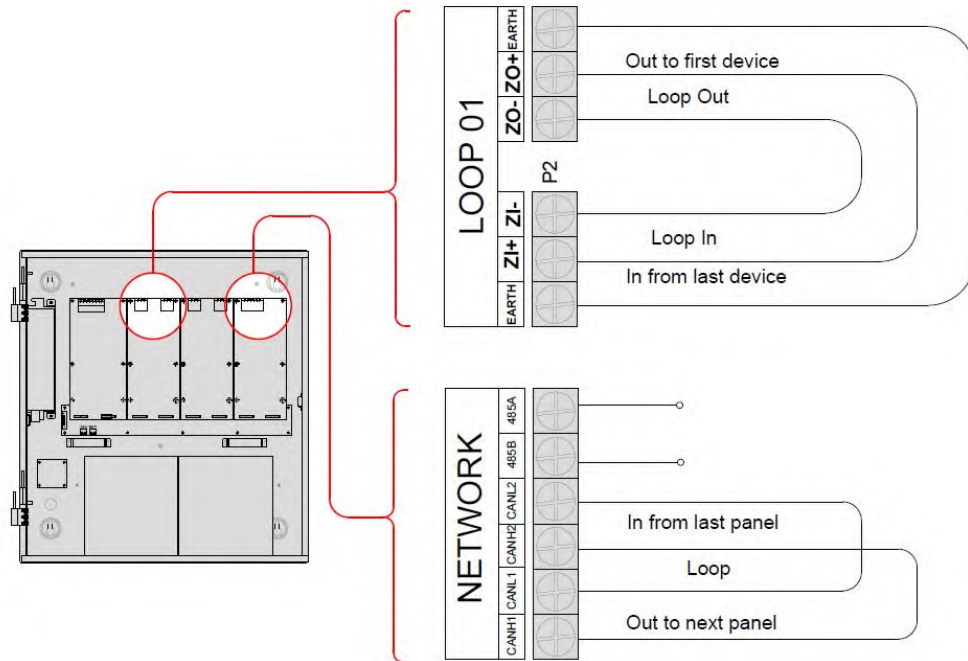

Figure 9: Loop and Network Wiring Details

LOOP1 to LOOP4: Each loop can have maximum 254 addressable devices. The FACP can have maximum 4 loops. If loop isolators are connected into the Class A loop, the detectors protected by the isolators will not be lost in case of short or open circuit with the loop, and the FACP reports loop fault.

Network (CANBUS SIGNAL): Communication cable for connecting with up to 99 network FACP. (CANH2, CANL2 of the previous FACP are to be connected with CANH1 and CANL1 of the next FACP, and CANH2, CANL2 of the next FACP are to be connected with CANH1 and CANL1 of the previous FACP.)

LAN PORT: Ethernet connection, for future use.

USB PORT: USB Connection used for hardware interface for attaching laptop in configuring the control panel. The length of cable should be less than 3m.

RS232 SERIAL PORT: Connection also used for hardware interface for attaching laptop in configuring the control panel. The 2nd pin (for sending data), the 3rd pin (for receiving data), and the 5th pin (ground) is connected with PC through three-core screened cable (**Note: the length of cable should be less than 15m; the screening layer and computer's enclosure should be earthed**).

RS485 SERIAL PORT: The same function with RS232 PORT, these two PORTS cannot be used simultaneously. In long distance communication, the RS485 PORT is used to replace the RS232 PORT.

3 Control Panel Descriptions

3.1 Control Pane Fascia

Before operating the system read first this chapter and is familiar with the panel user interface.

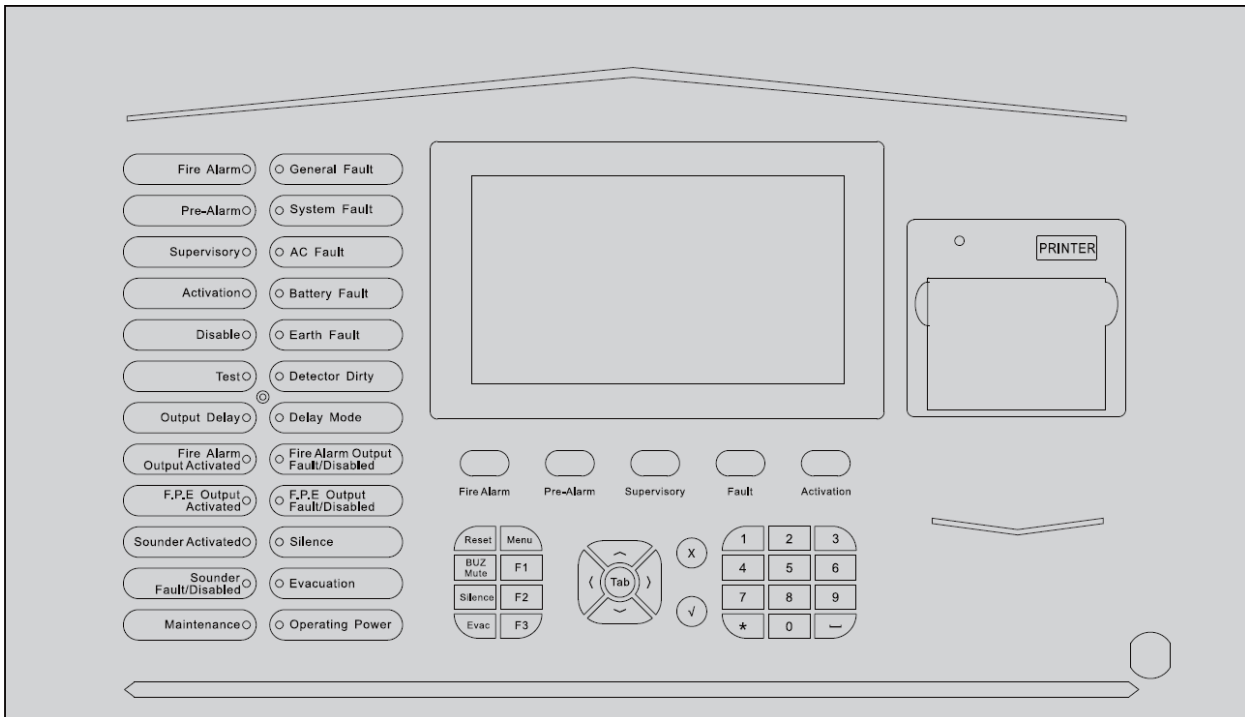

Figure 10

3.1.1 LED Indicator

Indicators	Colour	Description	How to clear
Display:		This provides the message of the events and system status.	
Fire Alarm	RED	When illuminated it indicates that a FIRE has been detected in the protected location	Attend the condition and perform the panel reset
General Fault	YELLOW	When illuminated it indicates that a FAULT has been detected in the devices and alarm system.	Correct the condition that cause fault and automatically clear the indication or perform a panel reset
Pre-Alarm	RED	When illuminated it indicates that a PRE-ALARM has been detected in the specified zone(s)	Attend the condition and press the ACK button to turn the system to Pre-alarm verification.
System Fault	YELLOW	When illuminated it indicates that the fault has occurred with the main processor. It is suggested to investigate the fault due to the panel will not able to attend the fires.	Turn –off and on the panel

Supervisory	RED	It illuminates when the panel receives Supervisory information. The devices whose types are between 31 and 55 can carry out supervisory information, which is similar to fire detector. Normally it is carried out from Input Modules.	Attend the condition and perform a panel reset
Activation	RED	It illuminates when the panel receives Activation information. The devices whose types are between 62 and 75(Common Group Devices) can carry out activation information. Normally it is carried out from Output Modules. (Note: Not include Sounder Group devices, the panel will not display Sounder Group Devices' activation information)	Attend the condition and perform the panel reset
Disable	YELLOW	When illuminated it indicates that part of the panel has been disabled	Enable the device/s and automatically clear the indication
Test	YELLOW	When illuminated it indicates one or more zones are in test mode.	Cancel test when finished
AC Fault	YELLOW	When illuminated it indicates that the main power has been failed	Test the AC power source or check the connections.
Battery Fault	YELLOW	Yellow. When illuminated it indicates that the battery has been failed.	Replace the battery or check the connections.
Earth Fault	YELLOW	When illuminated it indicates that the panel or loop wiring is grounded	Clear the ground fault
Detector Dirty	YELLOW	When illuminated it indicate that a dirty chamber has been detected in the specified smoke detector.	Clean the smoke chamber and perform the panel reset
Output Delay	YELLOW	When illuminated it indicates that part of the system output is block by delayed.	Wait until the time delay is laps. Or Override by pressing F1 function key. Or cancel by pressing F2 function key
Delay Mode	YELLOW	When illuminated it indicates that the system is set to Day mode that allows the system to follow the schedule delay time.	Disable the delay mode or Disable Delay mode Led indicator
Fire Alarm Output Activated	RED	It illuminates when the panel's OUT1 Circuit (Output to Sounder) is activated.	Perform the panel reset
FPE Output Activated	RED	It illuminates when the panel's OUT2 Circuit (Output to FPE) is activated.	Perform the panel reset
Fire Alarm Fault /Disable	YELLOW	When illuminated it indicates that the Output to Sounder circuit has been disabled or fault is occurred	Enable the device/s and attend the condition
FPE Fault /Disable	YELLOW	When illuminated it indicates that the Output to FPE circuit has been disabled or fault is occurred	Enable the device/s and attend the condition
Sounder Activated	RED	It illuminates when the loop sounder is activated.	Perform the panel reset

Sounder Fault /Disable	YELLOW	When illuminated it indicates that a fault or disable in the loop sounders.	Cancel after corrected the condition that cause sounder fault.
SILENCE	YELLOW	When illuminated it indicates that the SILENCE button has been pressed and the panel is silenced.	Correct the alarm condition then perform the panel rest. Note: If there a new alarm occurs, the panel will resound again.
Evacuation	RED	When illuminated it indicates that the EVAC button has been pressed	
Maintenance	YELLOW	When illuminated it indicates that the panel is in programming mode.	Exit the programming menu, and automatically clear the indication
Operating Power	GREEN	When illuminated it indicates the power supply is present	N/A

3.1.2 Display and Control Keypads Function

LCD SCREEN: Touch screen display, use for optional user interface aside from operational keypads which shows options that can be choose by touching the screen.

View Information: This is single-button activation. This allows easy single activation of viewing the most important information such as Fire Alarm, Pre-Alarm, Supervisory, Faults and Active.

Fire Alarm Info: When fire alarm occurs, the buzzer of the FACP sounds. Please first find out the location according to the information Shown on the FACP to verify whether the fire really happened. If it's a real fire, please take corresponding measures as outlined below.

Step 1: Press EVAC or F1 and F2 to evacuate the people in field.

Step 2: Call the fire department.

Step 3: Initiate extinguishers.

If it is a false alarm, please take the following measures

Step 1: Press SILENCE to stop the sound.

Step 2: Remove the causes of the false alarm.

Step 3: Press RESET to make the FACP back to the normal state. If the device still gives false alarm, disable it and inform the installer or manufacturer for repair.

Pre-Alarm Info: In case of a pre-alarm, the Pre-Alarm LED will illuminate, and the buzzer of the FACP will sound continuously. The FACP provides two types of dependency on more than one alarm signal in zone setup. If a zone is set as Type A dependency, the alarm of a detector from this zone will be reported as a pre-alarm, and only when there is another detector from the same zone alarms, will the FACP report a fire alarm. If a zone is set as Type B dependency, the alarm of a detector from this zone will be reported as a pre-alarm, and when there is another detector alarm from any zone, the FACP will report a fire alarm. In different working mode, the disposal of the pre-alarm signal will be different.

In night mode, if a zone is set as Type A dependency, the pre-alarm will be delayed for 30 minutes. If it's set as Type B dependency, the pre-alarm will be delayed for 5 minutes.

In day mode, if a pre-alarm comes, the screen will display the delay time Stage 1 for acknowledgement of the pre-alarm. Pressing ACK, the FACP will enter the delay time Stage 2 for verifying if it's a true fire alarm.

Supervisory Info: The display screen is the same as fire alarm.

Fault Info: The indication of the fault message depends on the type of fault. Specific fault types and causes are shown in Appendix 2.

AC fault: If the AC supply is down, the panel will report AC fault

Light AC FAULT LED.

The LCD displays "AC FAULT"

The panel generates fault sound.

Fault relay outputs.

Battery fault: The panel will reports battery fault if the battery voltage is lower than 21VDC or the internal resistance is higher than 1 ohm

Light GENERAL FAULT and BATTERY FAULT LED.

The LCD displays "BATTERY FAULT" or "BAT Resistance FAULT".

The panel generates fault sound.

Fault relay outputs.

System fault: The panel will report system fault if its control CPU and circuit is in fault and the panel cannot work normally. The panel will enter Safe state.

It lights the SYSTEM FAULT LED.

There is no display on the LCD.

The panel generates continuous alarm sound.

The keypad cannot be used.

After the fault is removed, the FACP has to be reset by rebooting.

Fault relay outputs.

Earth fault: When Loop Bus is connected to the earth, the FACP reports earth fault.

It lights the GENERAL FAULT and EARTH FAULT LED.

The FACP generates fault sound.

Fault relay outputs.

NOTE:

The Safe state: When the crystal oscillator occurs short circuit, the system enters into safe mode, which is the fault state of system.

If the crystal oscillator of Mainboard /loop Board occurs short circuit, the controller will report system fault. **RELAY2** Change-over, **OUT1/ OUT2/ AUX/ RELAY1 /RELAY3/ RELAY4** keep state.

If the Power Board enters into safe mode, the controller will report system fault. **RELAY2** Change-over, **RELAY1 /RELAY3/ RELAY4** keep state, **OUT1/ OUT2/ AUX** will be off.

If the crystal oscillator of Communication board/Zone Indication panel occurs short circuit, it will report communication fault.

Activation Info: When the device is activated manually or by linkage.

MENU: This buttons is used to access to the system menu. Each option in the menu corresponds to one number button. This is accessible under the manager password.

F1, F2, F3: This button is Functional keys. This allows easy single-button activation of the common used features.

RESET: This button allows resetting the control panel. Pressing the reset button perform a cold reboot allow to clear all current events then restore the panel to the normal condition.

BUZ MUTE: This button mutes the buzzer of the control panel. Pressing the mute button will stop the internal panel buzzer.

SILENCE: This button silences the alarm warning circuit and devices. Pressing the silence button will stop panel sounder output and the entire sounder devices in the loop which programmed as device type 56, 57, 58, 59, 60, 61.

EVAC: This button enables the alarm warning circuit and devices. Pressing the EVAC button will start panel sounder output and the entire sounder devices in the loop which programmed as device type 56, 57, 58, 59, 60, 61.

Numerical and Alphabetic Keys (1, 2ABC, 3DEF, 4GHI, 5JKL, 6MNO, 7PQRS, 8TUV, 9WXYZ, 0, \square , *): This button is used to enter the data manually at the control panel.

<>TAB^V: This button is for the position indicator on the display screen where a user can enter inputs.

X: This is a cancel button. Pressing the [X] button will cancel the operation and return to the main menu, and allow user to exit programming without saving.

√: This is an enter button. Pressing the [√] button will confirm saving settings and validate various option and messages.

3.1.3 Zone LED Indicator

Each FACP has a built-in two zone indication panels, appearance of which is shown in Figure 11.

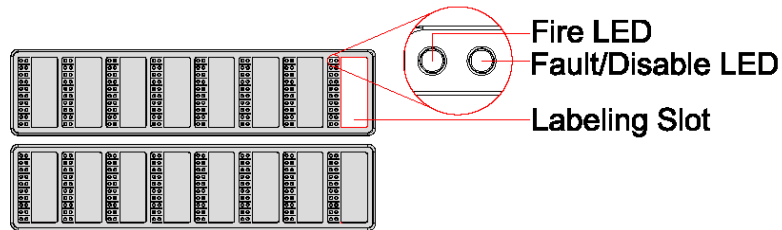

Figure 11: LED Indication

Display

The LED indicators support up to 80 displays. Each display can be identified according to the pre-configure setting on Zone Display Card LED Setup. The user can put the name of device on the right of the indicators.

Display Type	Indication					Description
	Fire	Fault	Disable	Test	Active	
Display Zone Status	RED Steady	Yellow Blinking	Yellow Steady	Yellow Steady	-	Zone indication
Display Group Status	-	Yellow Blinking	Yellow Steady	-	RED Steady	Group Indication
Display Loop Device Status	RED Steady	Yellow Blinking	Yellow Steady	-	RED" Steady	RED' = if device type is assigned to Fire signal RED" = if device type is assigned to Activation signal

LED indicator Board

The two LED board fits on the panel which can be extended up to 4 circuit boards. Each LED indicator position is identified through jumper setting as shown below:

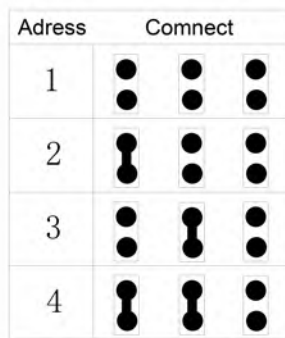

The last column is free,
there is no change to the gate

Figure 12

3.2 Type for Sound Indication

The FACP will give sound of higher priority if two types of event occur simultaneously.

The FACP gives continuous sound when fire alarm or Pre alarm occurs.

The FACP gives slow sound (0.5s on, 0.5s off) when there is supervisory message.

The FACP gives slow sound (1s on, 1s off) when fault occurs.

The FACP gives slow sound (2s on, 2s off) when Activation occurs.

4 System Commissioning

4.1 Preparation

Before switching on the panel ensures all electrical connections are tested, measured and visually checked and all the devices should be wired correctly.

4.2 Keypad/Keyboard Locking

The keypad and keyboard [touch-screen] can be locked by the user if desire. To unlock this control panel has three user access levels: Note, each access level has its own operating criteria.

Level 1: user access without entering pass code [Default Setting]

Level 2: user access with entering special pass code known as operation pass code [Default Setting 11111111]

Level 3: user access with entering special pass code known as commissioning pass code [Default Setting 22222222]

Level 4: factory level pass code

4.3 Basic Commissioning Procedures

1. Make sure all the addressable devices are encoded with the unique number. The address of the device is recommended to be consecutive number but not limited in order to have flexibility and should not be repeated.
2. Connect the loop with the panel as follow: Loop Out (+) to Loop In (+) / Loop Out (-) to Loop In (-).
3. Turn on the panel. Select the desire option as follow:
 1. Log-in Directly
 2. Enroll Additional Device
 3. Enroll All
4. The control panel should be set to commissioning mode in order to have a full access to any programming menu of the system. **Note:** It is required that after the commissioning is completed or before leaving the panel on the job site, always keep the system under the Monitoring mode to protect and secure the last made configurations.

Using touch-screen interface:

On the Main Menu tap **Commission Menu**. Input the Pass code [level 3] then tap **Panel Setup** and then tap **Function State Setup** and shows state selection.

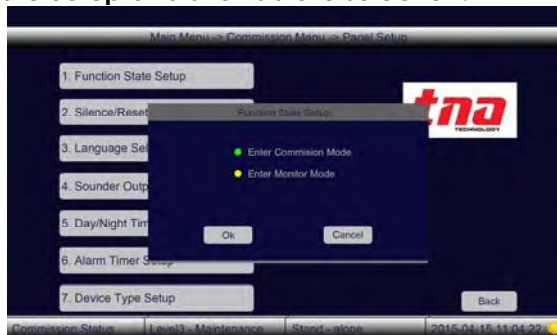

Figure 13

5. Set the passcode of the panel.
6. View the enrolled devices and compare to the project layout.
Using touch-screen interface:
On the Main Menu tap **Navigating Menu** then tap **View Panel Status** and then tap **View Loop Board** and shows number of total enrolled devices.
Using key-pad interface:
On the Key **Menu** press Menu, then press button **1**, then press button **1**, then press button **2 View Loop Board**.
7. Download the pre-configured data base from TX7810 programming software through a computer to the control panel. Refer to the TX7810 Defining Tool manual for more details.
8. Test the system.

5 Operation and Commission Menu

5.1 Navigating Menu Hierarchy

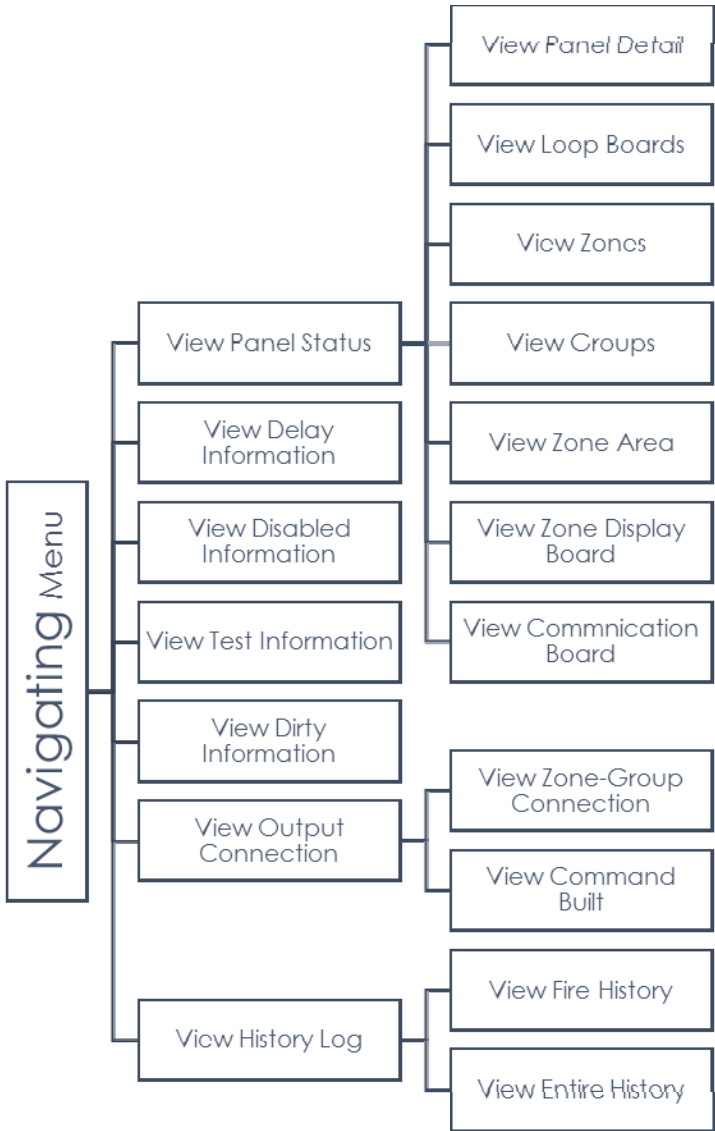

Figure 14



Figure 15

Navigation Menu

This menu provides to review alarm events history, the various system devices and their associated configurations. When a menu selection is made, the system displays the appropriate information. To access in this menu level 1 is required.

5.1.1 View Panel Status

This displays all the status and the latest information of your system. The detailed reporting status are divided into seven [7] sub-menus.

On the Main Menu tap **1 Navigating Menu** then tap **1 View Panel Status** and then view the sub-menus



Figure 16

5.1.1.1 View Panel Details

This display the total number of loops, devices, and display boards, zones, common and sounder groups monitored by the panel including panel main board software version

On the Main Menu tap **1 Navigating Menu** then tap **1 View Panel Status** and then tap **1 View Panel Details** and shows the details



Figure 17

5.1.1.2 View Loop Boards

This display the number of devices enrolled in the loop and loop software versions

On the Main Menu tap **1 Navigating Menu** then tap **1 View Panel Status** and then tap **2 View Loop Board** and shows the detail

For more additional details about on the particular loop configuration tap **F1** tab for device list and **F2** tab for loop map.



Figure 18



Figure 19: Loop details (F1)



Figure 20: Loop Map (F2)

5.1.1.3 View Zones

This display the total numbers of zones configured and the assigned devices on that particular zone.

On the Main Menu tap **1 Navigating Menu** then tap **1 View Panel Status** and then tap **3 View Zones** and shows the details

For additional details about on the particular zone configuration tap F1 tab.



Figure 21

5.1.1.4 View Groups

This display the total numbers of group configured and the assigned devices on that particular group.

Main Menu taps **1 Navigating Menu** then tap **1 View Panel Status** and then taps **4 View Groups** and shows the details

For additional details about on the particular group configuration tap F1 tab.



Figure 22

5.1.1.5 View Zone Area

This display the group of zones in a particular area

On the Main Menu tap **1 Navigating Menu** then tap **1 View Panel Status** and then tap **5 View Zone Area** and shows the details

For additional details about on the zone area tap F1 tab.



Figure 23

5.1.1.6 View Zone Display Board

This display the number of zones display board enrolled on the panel. Up to four zone display boards can install in the panel.

On the Main Menu tap **1 Navigating Menu** then tap **1 View Panel Status** and then tap **6 View Zone Area** and shows the details

For additional details about Zone Display Board tap F1.



Figure 24

5.1.1.7 View Communication Board

This display communication interface details.

On the Main Menu tap **1 Navigating Menu** then tap **1 View Panel Status** and then tap **7 View Communication Boards** and shows the details

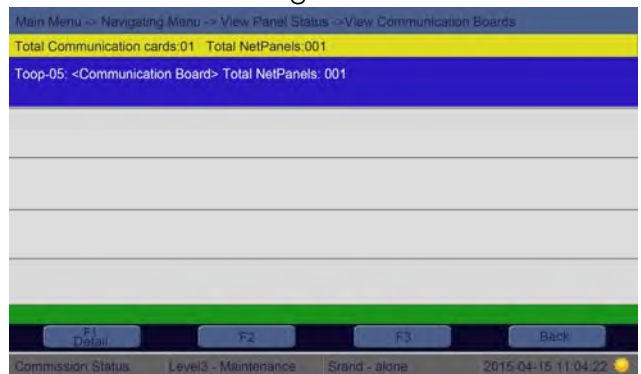

Figure 25

5.1.2 View Delay Information

This displays the delay time and associate configuration when active.

On the Main Menu tap **1 Navigating Menu** then tap **2 View Delay Information** and then shows the details



Figure 26

5.1.3 View Disable Information

This displays the disable information for the devices that this function is executed on.

On the Main Menu tap **1 Navigating Menu** then tap **3 View Disable Information** and then shows the details

The disabled device details can be printed by selecting it then tap the **F1** tab. It is also possible to enable the device directly by tapping the **F3** tab (need level 2 passcode).



Figure 27

5.1.4 View Test Information

This display the test information for the devices, zones that this function is executed on.

On the Main Menu tap **1 Navigating Menu** then tap **4 View Test Information** and then shows the details

The test device details can be printed by selecting it then tap the **F1** tab.



Figure 28

5.1.5 View Dirty Information

This displays information for the dirty a detector which required an immediate cleaning.

On the Main Menu tap **1 Navigating Menu** then tap **5 View Dirty Information** and then shows the details

The dirty detector details can be printed by selecting it then tap the **F1** tab.

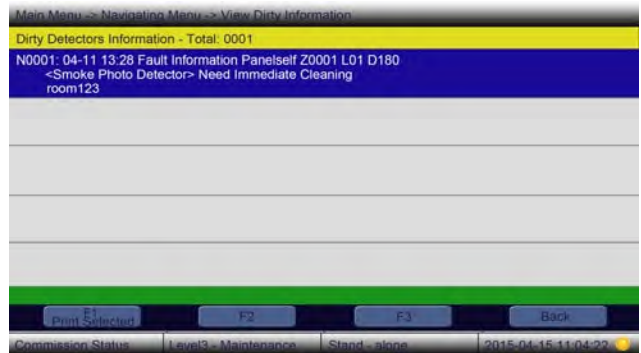

Figure 29

5.1.6 View Output Connection

This display the output connection information, its divided into two [2] sub-menus namely View Zone-Group Connection and View Command Built.

5.1.6.1 View Zone-Group Connection

This display the particular zone associated with number of groups and its delay time details in the event of fire and pre-alarm scenario.

On the Main Menu tap **1 Navigating Menu** then tap **6 View Output Connection** and then tap **1 View Zone-Group Connection** and shows the details

For other zone details type the zone number on the zone box.

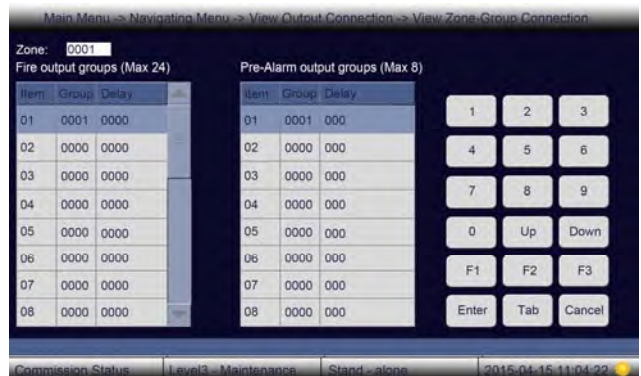

Figure 30

5.1.6.2 View Command Built

This displays the command built expanded formula between inputs and output devices.

On the Main Menu tap **1 Navigating Menu** then tap **6 View Output Connection** and then tap **2 View Command Built** and shows the details

For other formulas detail type the formula ID on the formula ID box.

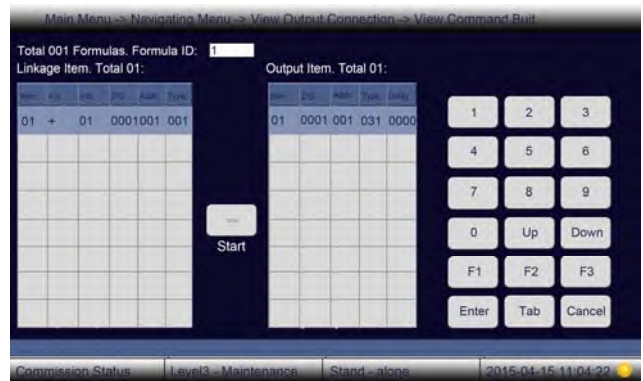

Figure 31

5.1.7 View History Log

The History memory is divided into two parts namely View Fire History and View Entire History.

5.1.7.1 View Fire History

This displays the fire history information. The history capacity is 1000 stored in non-volatile memory.

On the Main Menu tap **1 Navigating Menu** then tap **7 View History Log** and then tap **1 View Fire History** and shows the details

The fire history details can be printed by selecting it then tap the **F1** tab.



Figure 32

5.1.7.2 View Entire History

This display all the history information. The history capacity is 10,000 stored in non-volatile memory

On the Main Menu tap **1 Navigating Menu** then tap **7 View History Log** and then tap **2 View Entire History** and shows the details

The history details can be printed by selecting it then tap the **F1** tab.



Figure 33

5.2 Operation Menu Hierarchy

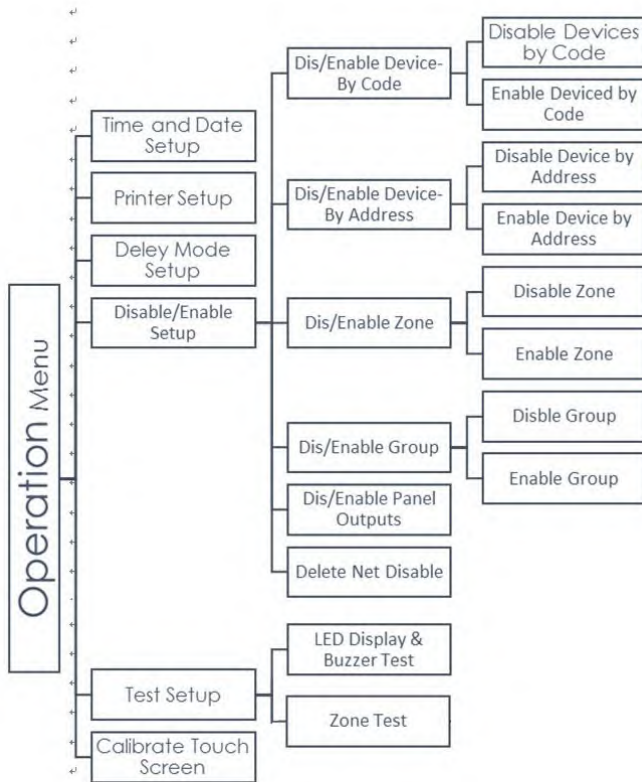

Figure 34

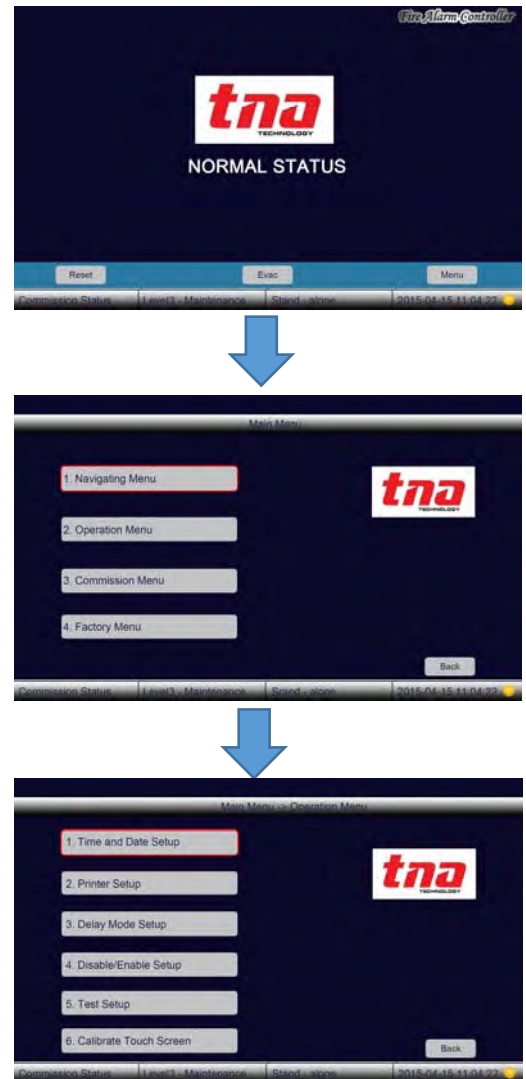

Figure35

Operation Menu

This menu provides system operation and function. To access in this menu level 2 is required.

5.2.1 Time and Date Setup

Selecting this option user allows to set the current time and date.

On the Main Menu tap **2 Operation Menu** then tap **1 Time and Date Setup** and shows present time and date



Figure 36

5.2.2 Printer Setup

Selecting this option user allow to set the printer for intended application.

On the Main Menu tap **2 Operation Menu** then tap **2 Printer Setup** and shows the option buttons.



Figure 37

5.2.3 Delay Mode Setup

Selecting this option user allow to disable or enable the delay mode.

Disable Delay mode, clicking this round button disable the delay time made from Command Builder and set the panel into Night mode.

Enable Delay mode, clicking this round button allows the panel to activate the "Day/Night Timer", the panel can switch the day and the night mode automatic.

Disable Delay mode Led indicator, In Enable Delay mode, clicking this round button allows the panel turn-off 'delay mode' LED indicator

Enable Delay mode Led indicator, In Enable Delay mode clicking this round button allows the panel illuminate 'delay mode' LED indicator

On the Main Menu tap **2 Operation Menu** then tap **3 Delay Mode Setup** and shows the option buttons then tap **OK** tab.



Figure 38

5.2.4 Disable/Enable Setup

Any or group of devices enrolled onto the panel can be disabled through manual operation by entering the address, group, zone and panel detail. Once it is disabled, even performing reset or turning off the panel will not operationally resume any device or group unless it is manually Enabled in these setup. Selecting this option user allows to disable or enable for the purpose of maintenance application.

On the Main Menu tap **2 Operation Menu** then tap **4 Disable/Enable Setup** and view the sub-menus.



Figure 39

5.2.4.1 Dis/Enable Devices by Code

On the Main Menu tap **2 Operation Menu** then tap **4 Disable/Enable Setup** and then tap **1 Dis/Enable by Code** and then tap **1 Disable Device by Code** or **2 Enable Device by Code** then type the Zone, device address and type number.



Figure 40



Disable by Code

Enable by Code

Figure 41

5.2.4.2 Dis/Enable Devices by Address

On the Main Menu tap **2 Operation Menu** then tap **4 Disable/Enable Setup** and then tap **2 Dis/Enable by Address** and then tap **1 Disable Device by Address** or **2 enable Device by Address** then type the loop and device address number.

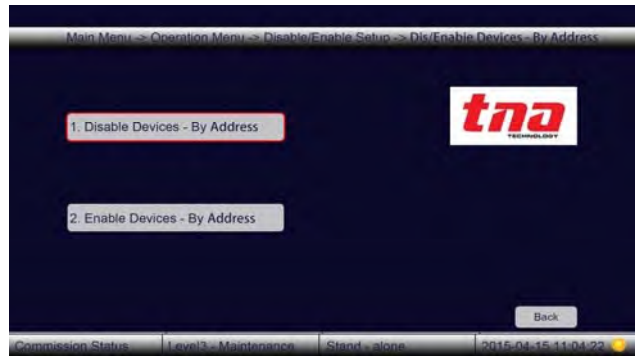

Figure 42



Disable by Address

Enable by Address

Figure 43

5.2.4.3 Dis/Enable Devices by Zone

On the Main Menu tap **2 Operation Menu** then tap **4 Disable/Enable Setup** and then tap **3 Dis/Enable Zone** and then tap **1 Disable Device Zone** or **2 Enable Device Zone** then type the Zone number.



Figure 44



Disable Zone

Enable Zone

Figure 45

5.2.4.4 Dis/Enable Devices by Group

On the Main Menu tap **2 Operation Menu** then tap **4 Disable/Enable Setup** and then tap **4 Dis/Enable Group** and then tap **1 Disable Device Group** or **2 Enable Device Group** then type the Group number.



Figure 46



Disable Group

Enable Group

Figure 47

5.2.4.5 Dis/Enable Panel Output

Selecting this option user allows to disable the panel output and by Default panel outputs are all enable.

On the Main Menu tap **2 Operation Menu** then tap **4 Disable/Enable Setup** and then tap **5 Dis/Enable Panel Outputs** and then tap desire disable option.

Note: Output 3 cannot be disabled

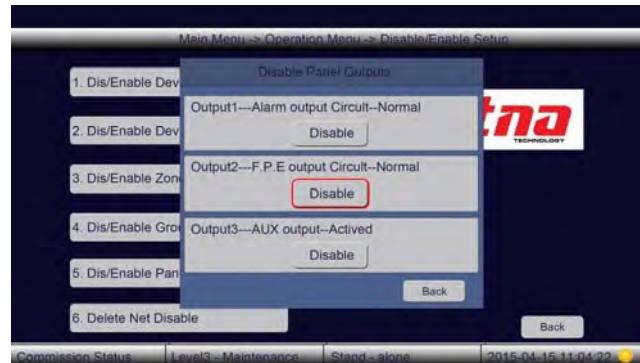

Figure 48

5.2.4.6 Delete Net Disable

Selecting this option user allows to delete the disable Information from the network.

On the Main Menu tap **2 Operation Menu** then tap **4 Disable/Enable Setup** and then tap **6 Delete Net Disable** and then type Enter



Figure 49

5.2.5 Test Setup

Any zone of devices enrolled into the panel can be tested through manual operation by entering the zone detail including LED and panel buzzer. Selecting this option user allow to test the system.

On the Main Menu tap **2 Operation Menu** then tap **5 Test Setup** and then view the sub-menus.



Figure 50

5.2.5.1 LED Display & Buzzer Test

Selecting this option user allow to test all panel LED indicators and built-in buzzer functionality.

On the Main Menu tap **2 Operation Menu** then tap **5 Test Setup** and then tap **1 LED Display & Buzzer Test** and then all LED's singly turn-on and alarm the buzzer, when done it stop automatically.

5.2.5.2 Zone Test

This option user allows setting a particular zone onto Test Mode. When testing, even performing system reset will not go out this mode unless it is manually Cancel in these setup.

On the Main Menu tap **2 Operation Menu** then tap **5 Test Setup** and then tap **2 Zone Test** and then type the zone number and click **Enter**.



Figure 51

Three things to be observed during test mode:

1. On the Zone Indication Panel, the corresponding zone number YELLOW LED is steady. And the TEST mode LED illuminate steady.
2. When a Fire signal from the Zone under the test mode, the screen display and print the fire event details, meanwhile the corresponding zone number LED illuminate steady.
3. Sounder Options, ON and OFF. On the Mode box type 0 to OFF-mode or type 1 to ON-mode.
OFF-mode, all the alarm warning device such as sounder, strobe and etc., assigned to zone will not alarm.
ON-mode, all the alarm warning device such as sounder, strobe and etc., assigned to zone will alarm within 10 seconds and then automatically stop.

Note: After the testing is done do not keep the control panel under the test mode. It is recommended to exit the test mode before leaving the site.

5.2.6 Calibrate Touch Screen

Selecting this option user allow to calibrate when the touch screen response inaccurate and erratic.



Figure 52: The first step



Figure 53: The second step

5.3 Commission Menu Hierarchy

(PART 1)

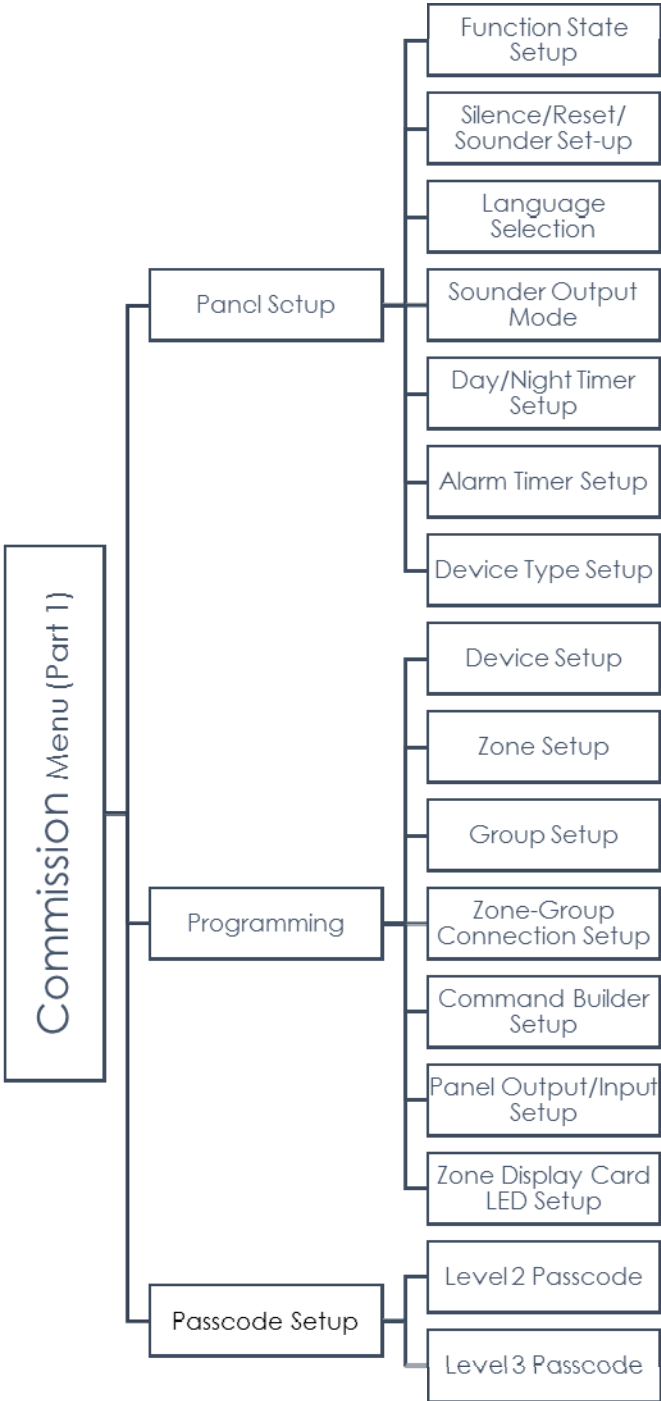

Figure 54

Commission Menu

This menu provides main system programming functions of the control panel. To access in this menu level 3 is required.



Figure 55

(PART 2)

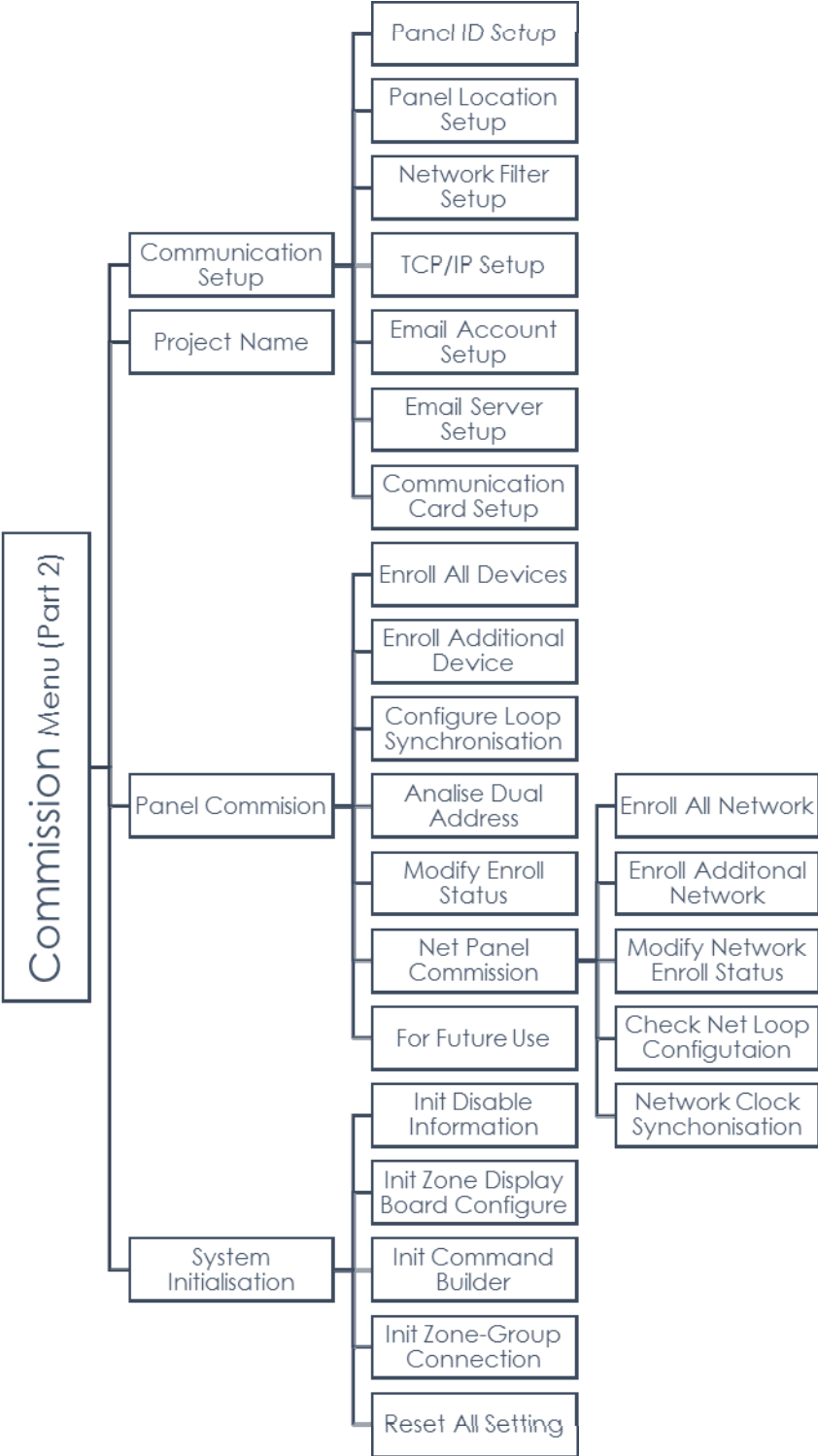

Figure 56

5.3.1 Panel Setup

Selecting this feature user allow to made important operating panel setting. The Panel Setup is divided into seven [7] sub-menus.

On the Main Menu tap **3 Commission Menu** then tap **1 Panel Set-up** and then view the sub-menus

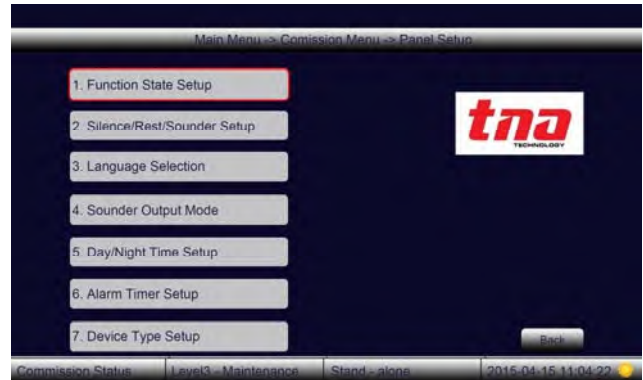

Figure 57

5.3.1.1 Function State Setup

Selecting this feature user allow to gain access in any programming menu. The Commission mode has a full access in common and commission menus while monitoring mode allow common and operation menus.

On the Main Menu tap **3 Commission Menu** then tap **1 Panel Set-up** and then tap **1 Function State Setup** and then show the option buttons.



Figure 58

5.3.1.2 Silence/Reset/Sounder Setup

Selecting this feature user allow to change the reset, silence and re-sound setting.

On the Main Menu tap **3 Commission Menu** then tap **1 Panel Set-up** and then tap **2 Silence/Reset/Sounder Setup** and then show the option button, click the desire feature than click **Okay**.

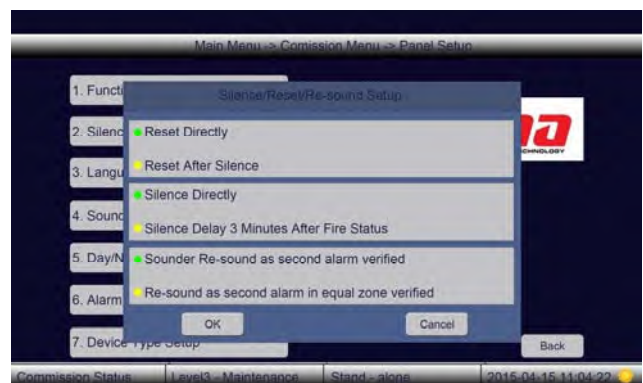

Figure 59

5.3.1.3 Language Selection

Selecting this feature allow user to select his language.

Note: Other languages will be added in the future.

On the Main Menu tap **3 Commission Menu** then tap **1 Panel Set-up** and then tap **3 Language Selection** and then show the option button.



Figure 60

5.3.1.4 Sounder Output Mode

Selecting this feature allows the user to control the sounder activation.

On the Main Menu tap **3 Commission Menu** then tap **1 Panel Set-up** and then tap **4 Sounder Output Mode** and then show the option button

Description:

Activate all sounder groups if selected, all the sounders in the loop will activate once a fire is detected by the panel.

Active by the linkage if selected, to the user can activate the loop sounders according to the predefined formula through Command Builder or Zone Group Connection.



Figure 61

5.3.1.5 Day/Night Timer Setup

Selecting this feature user allow to set day night time by typing onto the timer box. It only activates when the "**Delay Mode Setup**" is set to "**Enable Mode**". Once the Day mode is activated all of outputs delays which have been configured on the Command Builder will operate while on Night mode the all outputs delays are not permitted.

On the Main Menu tap **3 Commission Menu** then tap **1 Panel Set-up** and then tap **5 Day/Night Setup** and then show the option button.

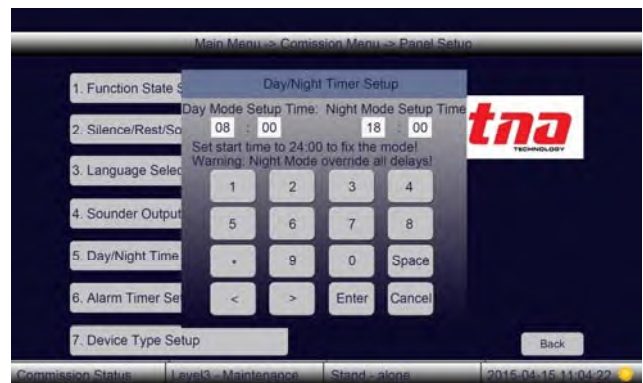

Figure 62

5.3.1.6 Alarm Timer Setup

Selecting this feature user allow to set the timer for each day of a week. Once the alarm timer is set up, it can be added on the Command Builder under the Linkage item as input parameters.

On the Main Menu tap **3 Commission Menu** then tap **1 Panel Set-up** and then tap **6 Alarm Timer Setup** and then type the time on the box.

Description: (refers to Command Builder)

Info type **11** refers to Timer 1 setting

Info type **12** refers to Timer 2 setting

Info type **13** refers to Timer 3 setting

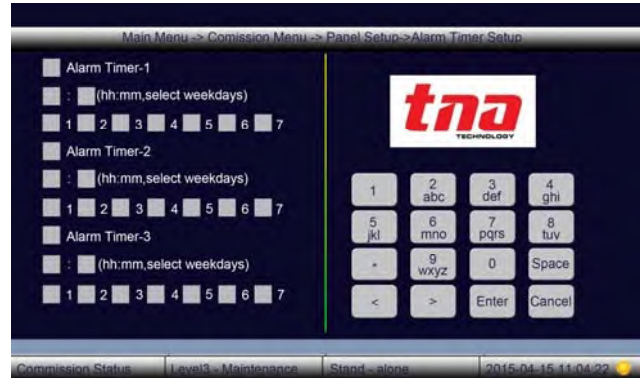

Figure 63

5.3.1.7 Device Type Setup

Selecting this feature user allow to set device type name of each device.

On the Main Menu tap **3 Commission Menu** then tap **1 Panel Set-up** and then tap **7 Device Type** and then type the device name.



Figure 64

Lists of Device Type

Signal Type	No.	Device Type	Signal Type	No.	Device Type
Undefined	0	UNDEFINED			
Fire Alarm [Zone]	1	Smoke Photo Detector	Supervisory (Unlatched)	46	Photo-SupervAR
	2	User-Defined		47	User-Defined
	3	Smoke Ion Detector		48	Tamper
	4	User-Defined		49	User-Defined
	5	Heat Detector		50	Supervisory-AR3
	6	User-Defined		51	HVAC OVERRIDE4
	7	Smoke DuctP. Detector		52	User-Defined
	8	User-Defined		53	Process-Monitor-AR2, 3
	9	Photo w/Heat Detector		54	User-Defined
	10	User-Defined		55	Sounder Strobe
	11	ADAPT	56	User-Defined	
	12	User-Defined	57	User-Defined	
	13	Beam Detector	58	Sounder	
	14	User-Defined	59	User-Defined	
	15	Gas Detector	60	Strobe	
	16	User-Defined	61	User-Defined	
	17	Flame Detector	62	Lift	
	18	User-Defined	63	Fire Damper	
	19	Water Flow Switch	64	Fire Door	
	20	User-Defined	65	AHU	
	21	Monitor	66	Extract Fan	
	22	User-Defined	67	BMS	
	23	Smoke-Conventional	68	User-Defined	
	24	User-Defined	69	User-Defined	
	25	Heat-Conventional	70	User-Defined	
			Activation [Sounder Group]		
			Activation [Common Group]		

Fire Alarm [Zone]	26	User-Defined		71	User-Defined
	27	Pull-Station		72	User-Defined
	28	User-Defined		73	User-Defined
	29	MCP (BG)		74	User-Defined
	30	User-Defined		75	User-Defined
Supervisory (Latched)	31	Duct-Supervisory	Fault	76	Power-Monitor
	32	User-Defined		77	Repeater
	33	Medic-Alert		78	Trouble-Monitor
	34	User-Defined		79	User-Defined
	35	Hazard-Alert2		80	User-Defined
	36	User-Defined	Input (For Future Use)	81	Ack-Switch
	37	Tornado-Alert2		82	Silence-Switch
	38	User-Defined		83	Reset-Switch
	39	Supervisory		84	Evac-Switch
	40	User-Defined		85	PAS-Bypass
	41	Process-Monitor2		86	HVAC Restart4
	42	User-Defined		87	Evac-Switch-AR3
	43	Zone Valve		88	Day_Night_Switch
	44	Flow Switch		89	User-Defined
	45	Pressure Switch		90	User-Defined

5.3.2 Programming

Selecting this feature user allow to program the control panel parameters, text description and fire scenario procedures. The Programming is divided into seven [7] sub-menus.

On the Main Menu tap **3 Commission Menu** then tap **2 Programming** and then view the sub-menus



Figure 65

5.3.2.1 Device Setup

Selecting this feature user allow to program the device parameter by typing onto parameters box.

On the Main Menu tap **3 Commission Menu** then tap **2 Programming** and then tap **1 Device Setup** and then type the parameters



Figure 66

Description:

Loop: Assign the loop number

Address: Assign unique number of device

Type: Assign the device type

Zone*: Assign the zone number

Group*: Assign the group number

Note *: Display either Zone or Group box according to the selected device type

Attribute: Use only for output module.

0 – Normal output

1 – Pulse output

Location: The place description of the device

5.3.2.2 Zone Setup

Selecting this feature user allow to program the zone parameter by typing on the parameter box

On the Main Menu tap **3 Commission Menu** then tap **2 Programming** and then tap **2 Zone Setup** and then type the parameters



Figure 67

Description:

Zone: Assign the zone number

Dependency: This feature complies with Dependency Mode. The signal from an automatic fire detection device selected for Dependency operation shall be acknowledged at the fire alarm control unit by a trained personnel within given time of annunciation in order to initiate the alarm investigation phase. If the signal is not acknowledged within the given time, alarm warning devices signals in accordance with the building evacuation or relocation plan and remote signals shall be automatically immediately activated

0 The system shall response to first alarm from any detector in the zone

1 The system shall response to a second alarm from any detector in the same zone as the system alarm (Type A)

2 The system shall response to a second alarm from any detector in the same or different zone of the same area as the system alarm (Type B)

Note: The manual call points are excluded in the Dependency mode

Pre-Alarm Acknowledge Time: From 1 sec to 300 seconds (5 minutes)

Pre-Alarm Verify Time: From 1 sec to 1800 seconds (30 minutes)

During Day Mode

The signal from an automatic fire detection device selected for Dependency operation shall be acknowledged at the fire alarm control unit by a trained personnel within given time of annunciation in order to initiate the alarm investigation phase. If the signal is not acknowledged within the given time, alarm warning devices signals in accordance with the building evacuation or relocation plan and remote signals shall be automatically immediately activated.

If the signal is acknowledged, The Panel will turn to Pre-Alarm Verify Mode. In the Verify time, if the signal is not acknowledged again within the given time, or the signal is acknowledged again, or the dependency condition is met, alarm warning devices signals in accordance with the building evacuation or relocation plan and remote signals shall be automatically immediately activated.

During Night Mode

Because there is no trained personnel to monitor the control panel in the night, the signal from an automatic fire detection device selected for Dependency operation shall make a Pre-Alarm information with a fixed delay time (Type A is 30 minutes and Type B is 5 minutes). Within the delay time, if there is a second alarm that meets the dependency condition, the Pre-Alarm will automatically change to a fire alarm, or the Pre-Alarm will cancelled automatically, the Panel returns to normal state.

5.3.2.3 Group Setup

Selecting this feature allow to program the group location by typing on the group box

On the Main Menu tap **3 Commission Menu** then tap **2 Programming** and then tap **3 Group Setup** and then type the location.



Figure 68

5.3.2.4 Zone-Group Connection Setup

Selecting this feature user allow to program relationship between the Zone and group.

On the Main Menu tap **3 Commission Menu** then tap **2 Programming** and then tap **4 Zone-Group Connection Setup** and then type the parameters



Figure 69

5.3.2.5 Command Builder Setup

Selecting this feature user allow to program set of commands in which any input to activate any output or groups of output, also known as Formula

On the Main Menu tap **3 Commission Menu** then tap **2 Programming** and then tap **5 Command Builder Setup** and then type the formula.



Figure 70

Linkage Item Description:

Info: In the info box select the signal information.

- | | | |
|-------------------------------|-------------------------------|---------------------------|
| 1- Fire Information | 9- Zone Disable Indication | 52- Supervisory Resume |
| 2- Zone Fire Information | 10- Group Disable Information | 53- Fault Resume in Zone |
| 3- Pre-Alarm Information | 11- Timer Alarm 1 | 54- Fault Resume in Group |
| 4- Supervisory Information | 12- Timer Alarm 2 | 55- Activation Resume |
| 5- Fault Information in Zone | 13 - Timer Alarm 3 | 56- Enable |
| 6- Fault Information in Group | 49- Fire Resume | 57- Zone Enable |
| 7- Activation Information | 50- Zone Fire Resume | 58- Group Enable |
| 8- Disable Information | 51- PreAlarm Resume | |

Z/G: Type either the zone or group.

Adder: Type the device address from 1 to 254

Type: Type the device type number

5.3.2.6 Panel Output/Input Setup

Selecting this feature user allows to configure panel output and input.

On the Main Menu tap **3 Commission Menu** then tap **2 Programming** and then tap **6 Panel Output/Input Setup** and then display sub-menus



Figure 71



Figure 72: 1 Relay Output Setup

Relay Selection:

- 0. – For Fault Signal
- 1. – For Pre-Fire Signal
- 2. – For Fire Signal
- 3. – For Supervisory Signal
- 4. – For Active Signal
- 5. – For Disable Signal
- 6. – For Test Signal

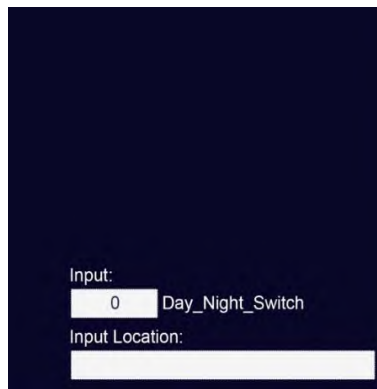

Figure 73: 2 Input Setup

Input Selection: (For Future Use)

- 0. – For Day Night Switch
- 1. – For Acknowledgment Switch
- 2. – For Silence Switch
- 3. – For Reset Switch
- 4. – For Evacuation Switch
- 5. – For PAS Switch

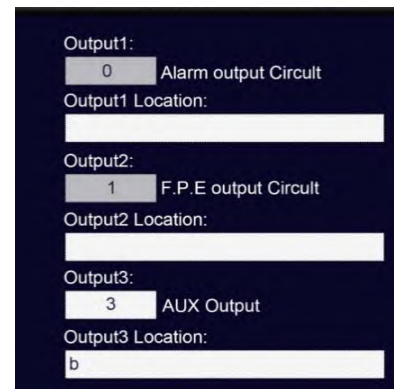

Figure 74: 3 Output Setup

Output Description

- 0. – Alarm Output Circuit
- 1. – F.P.E. Output Circuit
- 2. – Reserved
- 3. – Auxiliary Output Circuit
- 4. – Resettable Aux Circuit

5.3.2.7 Zone Display Card LED Setup

Selecting this feature user allows to configure zone indicator panel

On the Main Menu tap **3 Commission Menu** then tap **2 Programming** and then tap **7 Zone Display Card LED Setup** and then type the zone LED.



Figure 75

5.3.3 Pass code Setup

Selecting this feature user allows to program the panel access pass code.

On the Main Menu tap **3 Commission Menu** then tap **3 Passcode Setup** and then display the sub-menus



Figure 76



Figure 77: Operate Pass code-**Level 2**

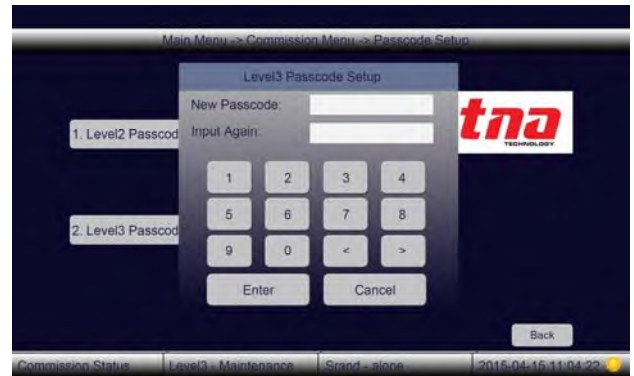

Figure 78: Commission Pass code-**Level 3**

5.3.4 Communication Setup

Selecting this feature user allow to configure the panel to panel communication and panel to other third party system communication. The Communication Setup is divided into seven [7] sub-menus.

On the Main Menu tap **3 Commission Menu** then tap **4 Communication Setup** and then display the sub-menus



Figure 79

5.3.4.1 Panel ID Setup

Selecting this features user allows to configure the local panel ID

On the Main Menu tap **3 Commission Menu** then tap **4 Communication Setup** and then tap **1 Panel ID Setup** and then type number on the Input Panel ID box.



Figure 80

5.3.4.2 Panel Location Setup

Selecting this feature user allows to configure the local panel description

On the Main Menu tap **3 Commission Menu** then tap **4 Communication Setup** and then tap **2 Panel Location Setup** and then type ID number and Location on the box.



Figure 81

5.3.4.3 Network Filter Setup

Selecting this feature user allows to configure the local panel to set as a master or slave panel.

On the Main Menu tap **3 Commission Menu** then tap **4 Communication Setup** and then tap **3 Network Filter Setup** and then choose whether to receive the network panel' information or command on the box.

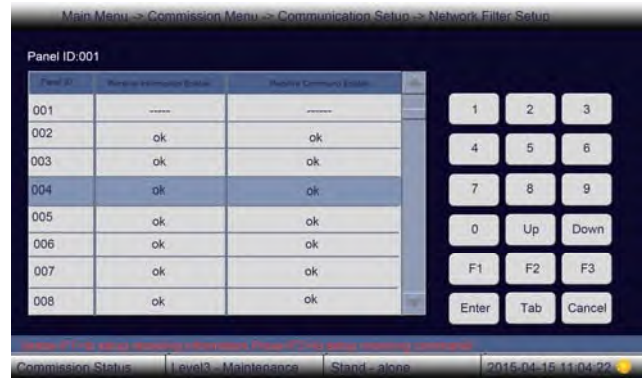

Figure 82

5.3.4.4 TCP/IP Setup

Selecting this feature user allows to set the local panel TCP/IP configuration. This is for future use.

On the Main Menu tap **3 Commission Menu** then tap **4 Communication Setup** and then tap **4 TCP/IP Setup** and then type the configuration on the box.

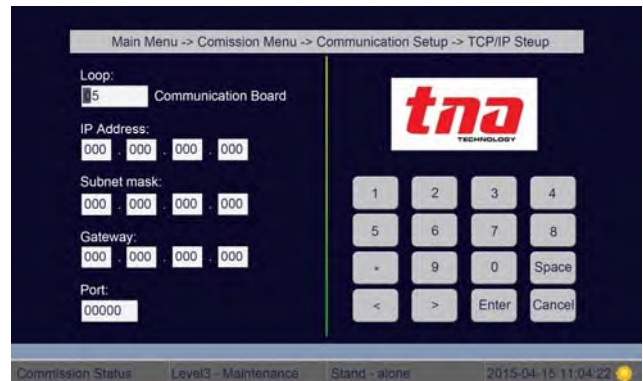

Figure 83

5.3.4.5 Email Account Setup

Selecting this feature user allows to set the local panel email account configuration. This is for future use.

On the Main Menu tap **3 Commission Menu** then tap **4 Communication Setup** and then tap **5 Email Account Setup** and then type the configuration on the box.



Figure 84

5.3.4.6 Email Server Setup

Selecting this feature user allows to set the local panel email server configuration. This is for future use.

On the Main Menu tap **3 Commission Menu** then tap **4 Communication Setup** and then tap **6 Email Server Configuration** and then type the configuration on the box.



Figure 85

5.3.4.7 Communication Card Setup

Selecting this feature user allows to set the local panel card configuration. This is for future use.

On the Main Menu tap **3 Commission Menu** then tap **4 Communication Setup** and then tap **7 Communication Card Setup** and then type the configuration on the box.

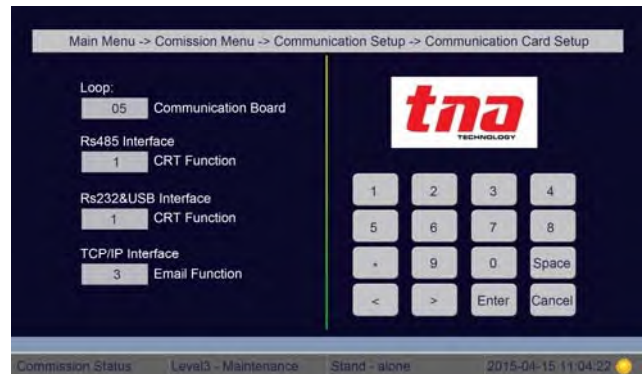

Figure 86

5.3.5 Project Name

Selecting this feature user allows to set the name or description of the local panel up to 40 characters which will display on the corner screen.

On the Main Menu tap **3 Commission Menu** then tap **5 Project Name Setup** and then type the name on the project name box.



Figure 87

5.3.6 Panel Commission

Selecting this function user allows to enroll all the addressable devices connected in the loop to the control panel.

On the Main Menu tap **3 Commission Menu** then tap **6 Panel Commission** and then display the sub-menus

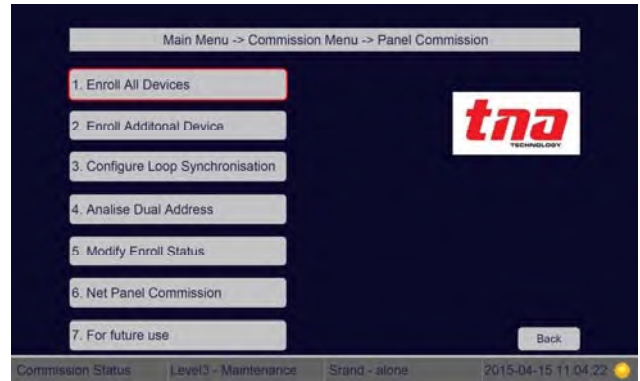

Figure 88

Panel Commission Menu:

1 Enroll All Devices

When selected, the control panel will enroll all the addressable devices connected in each loop.

2 Enroll Additional Devices

When selected, the control panel will enroll the new added addressable device(s) connected in each loop.

3 Configure Loop Synchronisation

When the panel have Synchronisation fault, we shall select it to synchronic the loop card' data with the panel. Normally we use this function when we change the loop card.

4 Analyses Dual Address

When selected, the panel will read and analyze all the devices address. When the system found duplicated address it will display the loop and the device number.

5 Modify Enroll Status

When selected, the panel will allow to modify the previous device configuration

5.3.6.1 Net Panel Commission

Selecting this function user allows to enroll all a local panel to the network connected in the loop to the control panel.

On the Main Menu tap **3 Commission Menu** then tap **6 Net Panel Commission** and then display the sub-menus

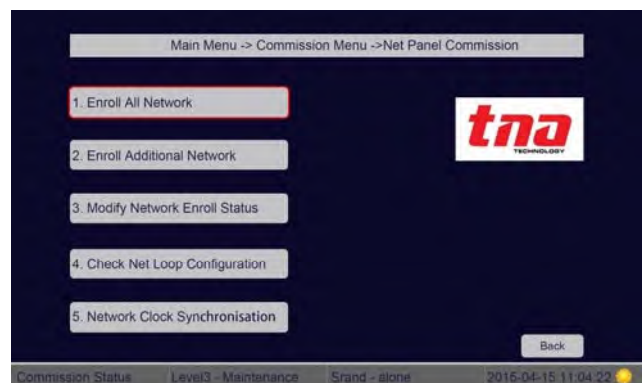

Figure 89

Network Panel Commission Menu:

- 1 Enroll All Network** When selected, the control panel will enroll all the control panels connected in the network.
- 2 Enroll Additional Network** When selected, the control panel will enroll new added additional panel into the existing network.
- 3 Modify Network Enroll Status** When selected, the panel will allow modifying the panel status in the existing network.
- 4 Check Net Loop Configuration** When selected, the panel will check the memory map which is distributed to store the loop devices' configuration of the panels in the network. A panel supports storing 500 loops' device configuration of the network panel.
- 5 Network Clock Synchronisation** When selected, the internal clock timer will synchronize to all the panels in the network,

5.3.7 System Initialisation

Selecting this function user allows to initialise or reset the control panel.

On the Main Menu tap **3 Commission Menu** then tap **7 System Initialisation** then display the sub-menus

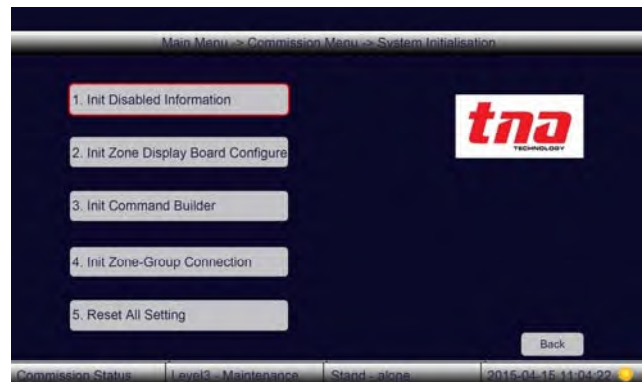

Figure 90

System Initialisation Menu:

- 1 Init Disable Information** When selected, the control panel will initialise and delete all disable status and then resume the operation.
- 2 Init Zone Display Card Configure** When selected, the control panel will initialise and delete all zone display information.
- 3 Init Command Builder** When selected, the panel will allow will initialise and delete all the formulas configured on Command Builder.
- 4 Init Zone-Group Connection** When selected, the panel will allow will initialise and delete all the formulas configured on Zone-Group Connection
- 5 Reset All Setting** When selected, the control panel will reset and then all the system programming information will be lost(need level 4 passcode).

6 Maintenance

6.1 Maintenance Schedule

The User should be regularly tested and serviced the system. The BS5839-P1 makes the following recommendations.

Daily Check

1. Check that the panel indicates normal operation. If not record any fault indicated in the history log and report to the responsible person.
2. Check that any fault recorded from the previous day has received attention.

Monthly Check

1. Operate at least one manual call point or detector [different device each month] to ensure the system operates properly.
2. Check the alarm warning devices have operated and then reset the panel.
3. Any defect should be reported and recorded in the log book.
4. Action should be taken to correct the defect.

Quarterly Check

1. Check entries in the log book and take any necessary action.
2. Inspect the batteries and their connections.
3. Operate at least one manual call point or detector [different device each zone] to ensure the system operates properly.
4. Check all the alarm warning devices have operated and then reset the panel.
5. Check that all function of the control panel operates by simulating fault conditions.
6. Visually check that structure alternation against any corrosion due to environmental effect.
7. Any defect should be reported and recorded in the log book. Action should be taken to correct the defect.

Annually Check

1. Carry out an inspection as detail for this quarterly inspection.
2. Every detector should be tested in the site.
3. All cable fittings and equipment should be checked to ensure that they are secure and undamaged.

6.2 Trouble Shooting

What you notice	What it means	What to do
No indication on the panel or abnormal indication	Power is abnormal Loose connection with switchboard.	Check and replace low-voltage switch power. Check the connection to display board.
Display "AC Fault" after power-up	No AC power	Check and connect AC wire.
Display "Battery Fault" after power-up	Loose connection with battery. Battery discharged or damaged.	Open the power box and check relative parts. Power up for more than eight hours with the AC power supply, if the fault still exists, replace the batteries.
Unable to register loop equipment	Bus wrong or loose connection	Check the loop
Unable to register repeater panels	Wrong or loose connection of communication cables	Check power supply to repeaters and communication wires
Cannot print	Print mode is disabled. Loose connection with printer. Printer damaged	Enable the print mode. Check and connect the printer well. Replace the printer.
Equipment fault	Equipment disconnected. Equipment damaged.	Check connection Replace equipment
Loop fault	Loop is shorted Loop is Interruption (The devices are re-established within 100s)	Check the loop and repair.
Clock or memory fault.	External interference. Corresponding parts are aging.	Check if the FACP is properly earthed. Inform our technical service

7 Battery Capacity

The standby battery is not supplied with the panel. It is recommending use two new rechargeable and sealed lead acid type batteries with capacity and sized according to the authority having jurisdiction.

Use a battery of an appropriate capacity to ensure the system is running in the event of failure of the main power source.

The user should calculate the capacity of the battery according to the panel current consumption before connecting to the panel. The Equation for calculating the battery capacity is listed below:

$$\text{Battery capacity (Ah)} = I_{Q_{max}} \times T_1 + (I_{Q_{min}} + I_{L_{max}} + I_{F_{out}}) \times T_2$$

In which:

$I_{Q_{max}} = 0.93A$, which is the quiescent current when the FACP is full-loaded;

$I_{Q_{min}} = 0.45A$, is the quiescent current when the FACP is with no load;

$I_{L_{max}} = 0.48A$, is the maximum loop current;

$I_{F_{out}} = 0.5A + 0.5A + 0.5A = 1.5A$, which is the alarm output current (The FACP provides 3 fire alarm outputs; output current of each is 0.5A, 0.5A and 0.5A respectively).

T_1 is the monitoring time when the FACP is full-loaded, which shall be at least 24 hours according to EN 54-4.

T_2 is the alarm time which shall be at least 30 minutes according to EN 54-4.

From the above equation, we can get the battery capacity is 23.54Ah, so that a 28Ah battery is recommended.

8 Returns and Warranty Policy

Warranty Policy

TANDA UK products are warranted to be free from defects in materials and workmanship for one [1] form the date of purchase from an authorized distributor or agent or two [2] years from the date of manufactured. Within this period, we will at our sole discretion, repair or replace any components that fail in normal use. Such repairs or replacement will be made at free of charge for parts and/or labor provided that you shall be responsible for any transportation charges. Replacement product may be new or refurbished at our discretion.

This warranty does not apply to consumable parts; damage cause by accident, abuse, misuse, flood, fire or other act of nature or external causes; damage caused by service performance by anyone who is not authorize agent or trained personnel; damage to a product that has been modified or altered without the prior written permission of TANDA UK.

Return

Please contact our Customer Service prior to returning any product to receive a return authorization form and RMA number. You will be responsible for, and pre-pay, all return shipping charges and shall assume all risk of loss or damage to product while in transit to us. We recommend that you use a traceable method of shipping for your protection. We will pay for shipping to return any product to you.

Email us info@tandauk.com to obtain an RMA number. Once you have obtained the RMA number, please send to us the purchased TNA product with the RMA number clearly marked on the outside of the package and on the shipping slip if you choose to use traceable carrier. Return shipping instruction and returns address will be included in your RMA documents.

9 Appendix 1

9.1 EN54 Part 2 /4 Compliance

TX7004 Intelligent Fire Alarm Control Panel (FACP) complies with the requirements of EN54-2 1997 + A1: 2006 and EN 54-4 1997 + A1: 2002 + A2: 2006. In addition to the basic requirements of these standards, the panel conforms to the following optional requirements.

EN54✓		Option	EN 54-2 Clause
	Indication	Alarm counter	7.13
		Delays to Output	7.11
		Dependencies on more than one alarm signal	7.12
		Disabling of addressable points	9.5
Outputs		Output to fire alarm devices	7.8
		Output to fire protection equipment	7.10
	Test	Test condition	10

The power supply of TX7004 FACP complies with EN 54-4 requirements.

EN54✓		EN 54-4 Clause
	Power supply from the main power source	5.1
	Power supply from the standby power source (battery)	5.2
	Charger	5.3
	Faults	5.4

In addition to functions required by EN54-2, the panel supports a number of ancillary functions that are not required. These are outlined below:

Ancillary Function	Manual Section
Printer	3.2.1
TX7004 Communication Card	2.3
TX7810 Defining Tool	3.4

9.2 Index of Information Required

EN54-2 Clause 12.2		Chapters or sections in this manual
	General description of the equipment	Chapter 1
12.2.1.a	Optional functions with requirements of EN54-2, functions relating to EN54-4, ancillary functions not required by EN54-2	Section 9.1
	Power requirement for recommended operation	Section 2.4.1
	Maximum capacity per detection circuit	Section 1.2
12.2.1.b	Maximum capacity per FACP	Chapter 1
	Electrical ratings for inputs and outputs	Section 2.4.2
	Communication parameters on transmission paths	Section 2.4.3
	Fuse ratings	Section 2.4.1
12.2.1.c	Installation information	Chapter 2
12.2.1.d	Configuring and commissioning instructions	Section 5.3
12.2.1.e	Operating instructions	Section 5.1,5.2
12.2.1.f	Maintenance information	Chapter 6